

DOUBLAGE DE 100mm / ISOLATION 100mm

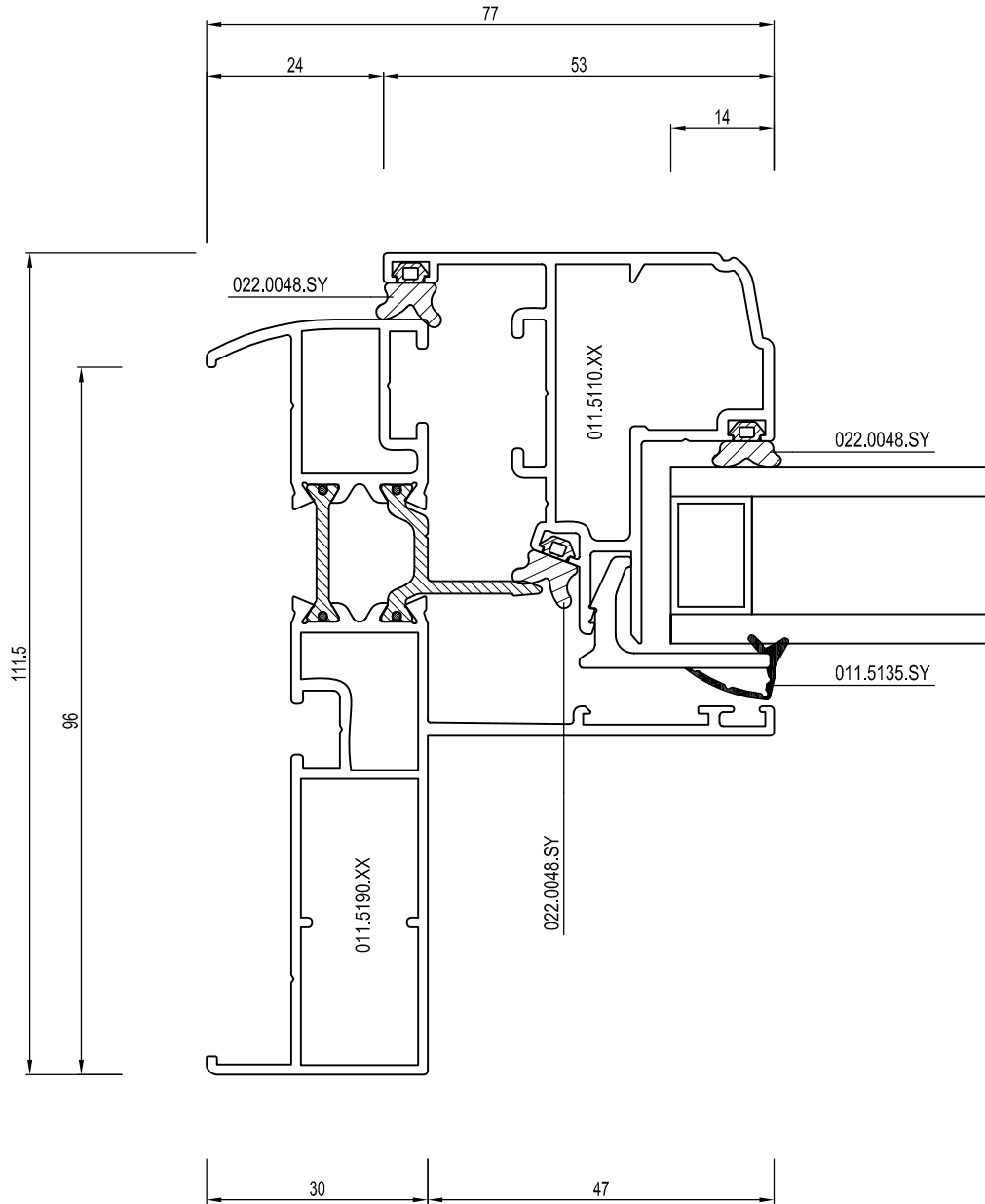

DOUBLAGE DE 120mm / ISOLATION 120mm

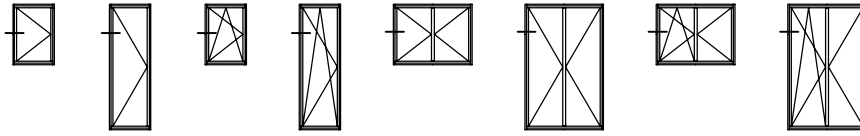
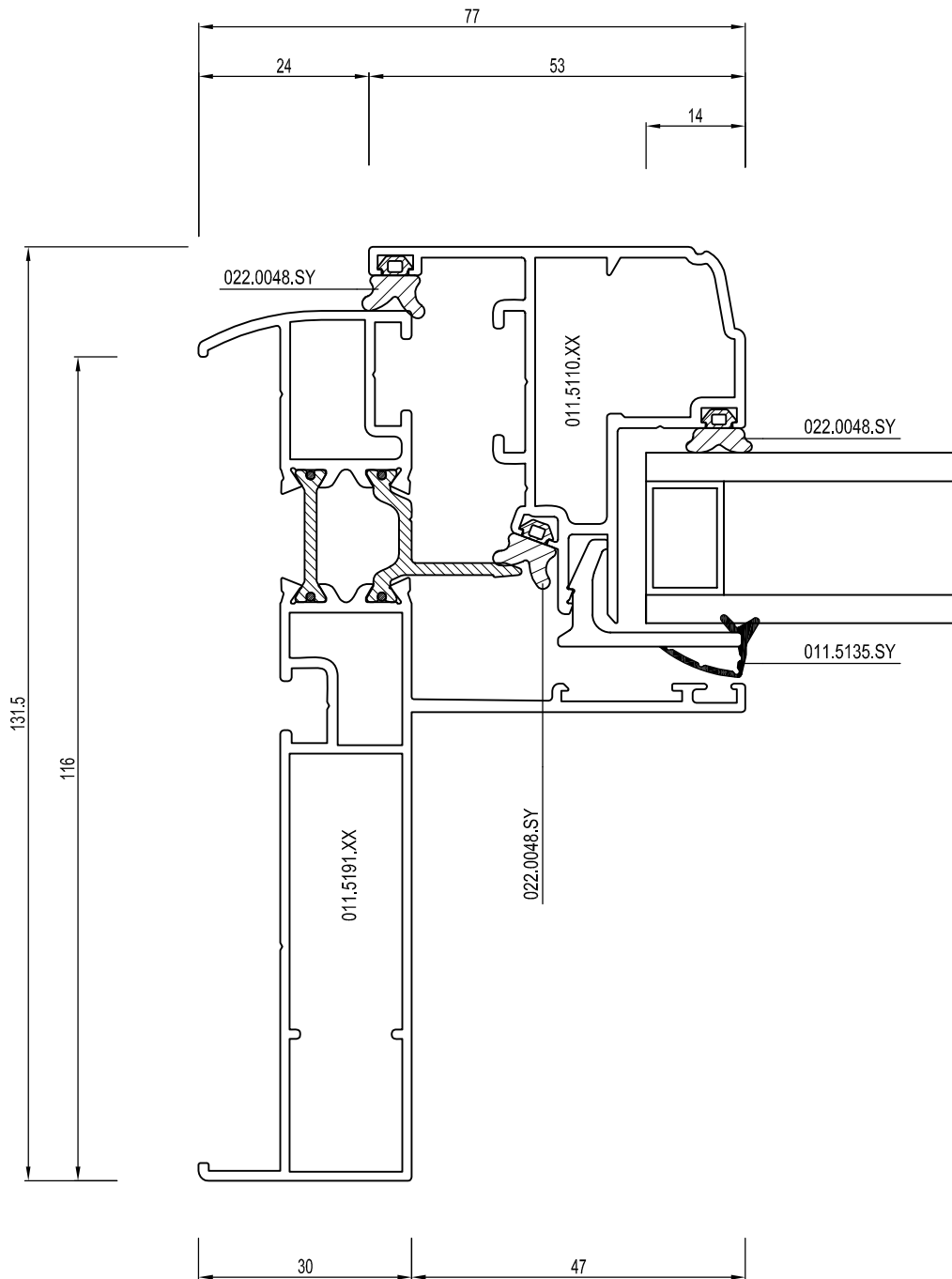
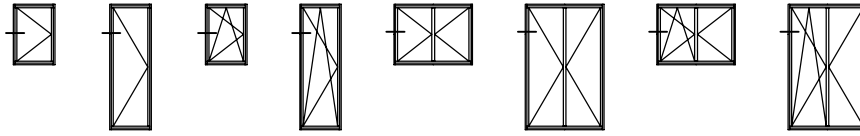

DOUBLAGE DE 140mm / ISOLATION 140mm

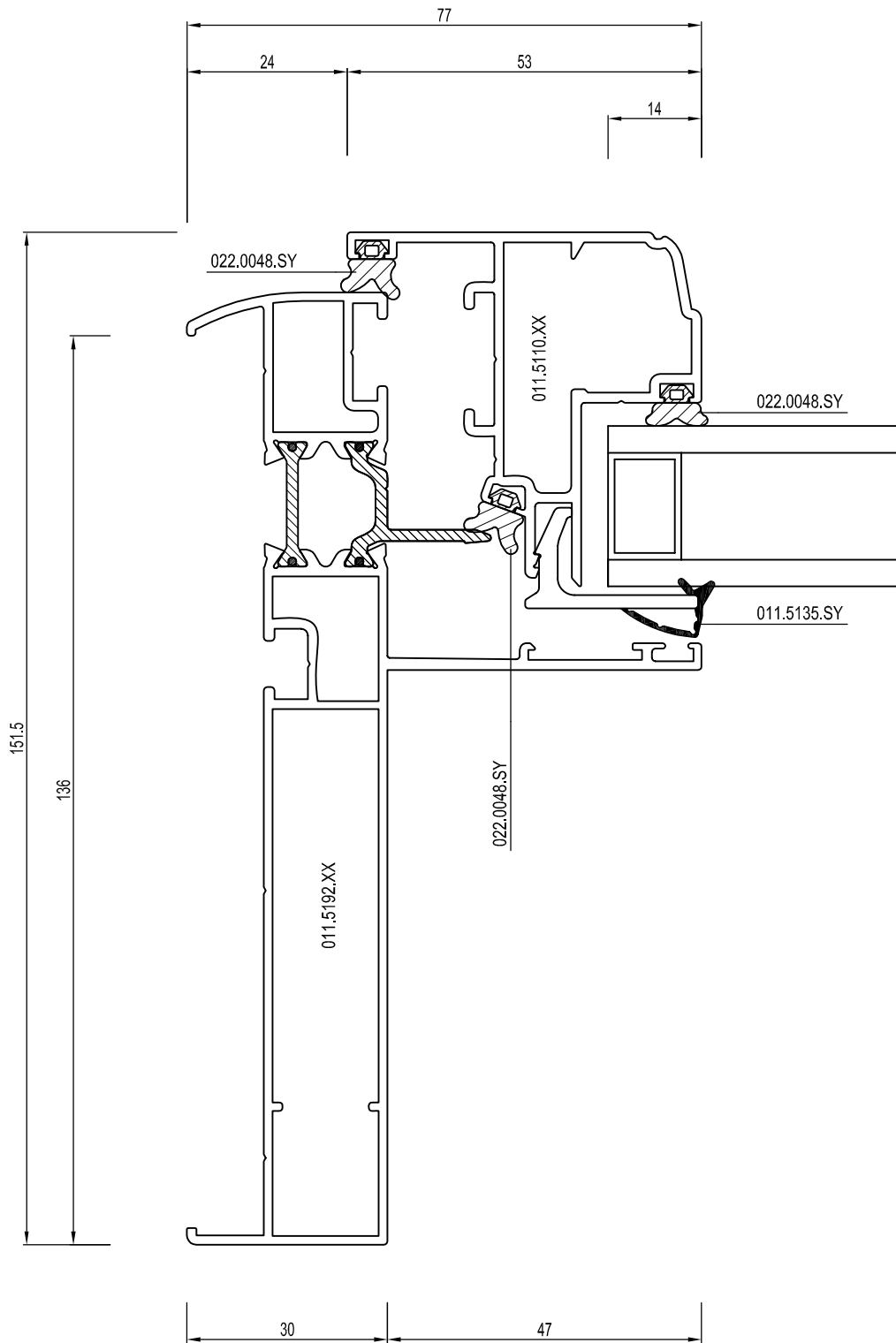
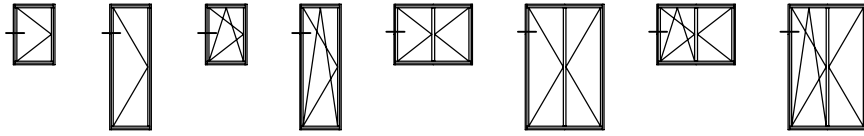

DOUBLAGE DE 160mm / ISOLATION 160mm

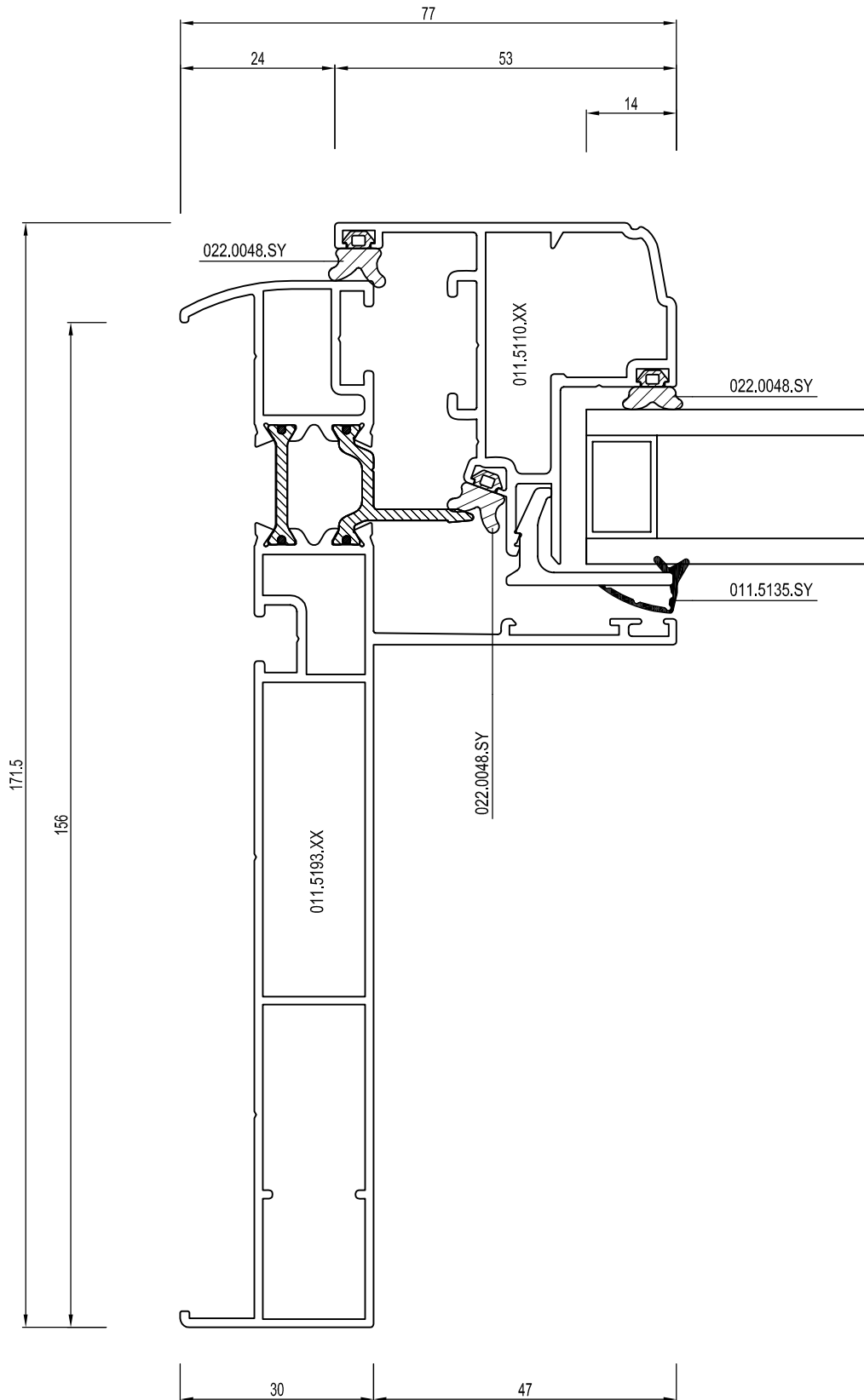
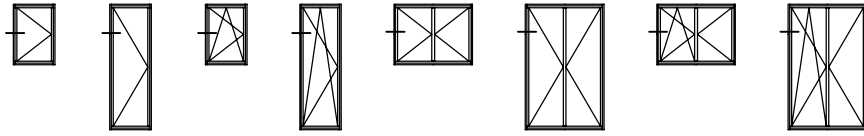

DOUBLAGE DE 100 ET 120mm / ISOLATION 100 AND 120mm

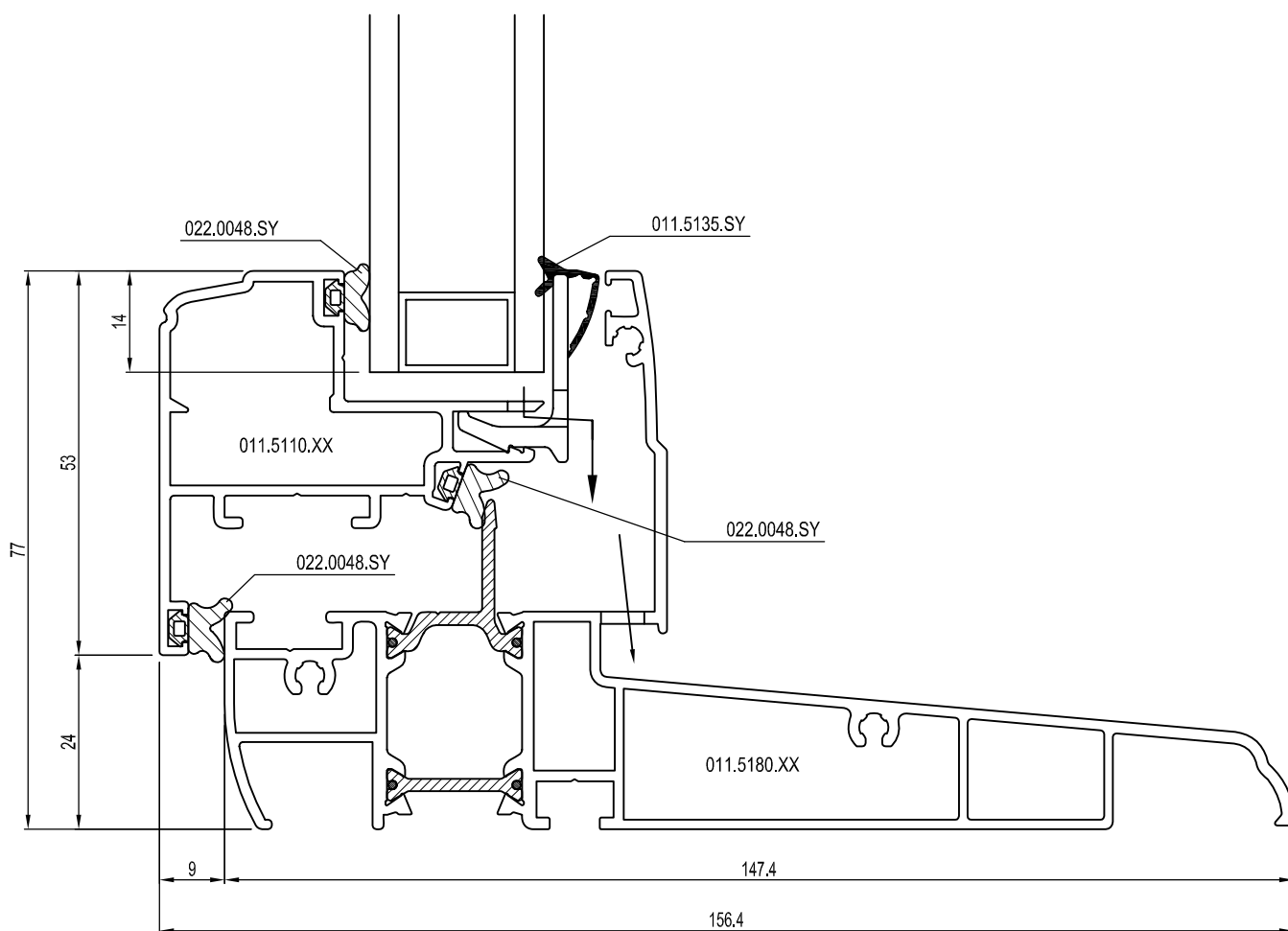
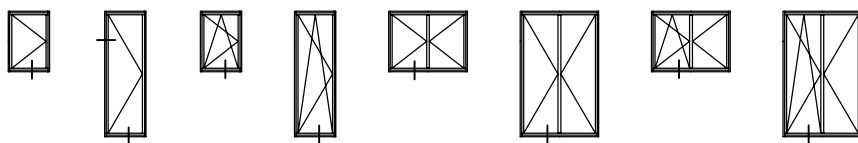

D0035508

DOUBLAGE DE 140 ET 160mm / ISOLATION 140 AND 160mm

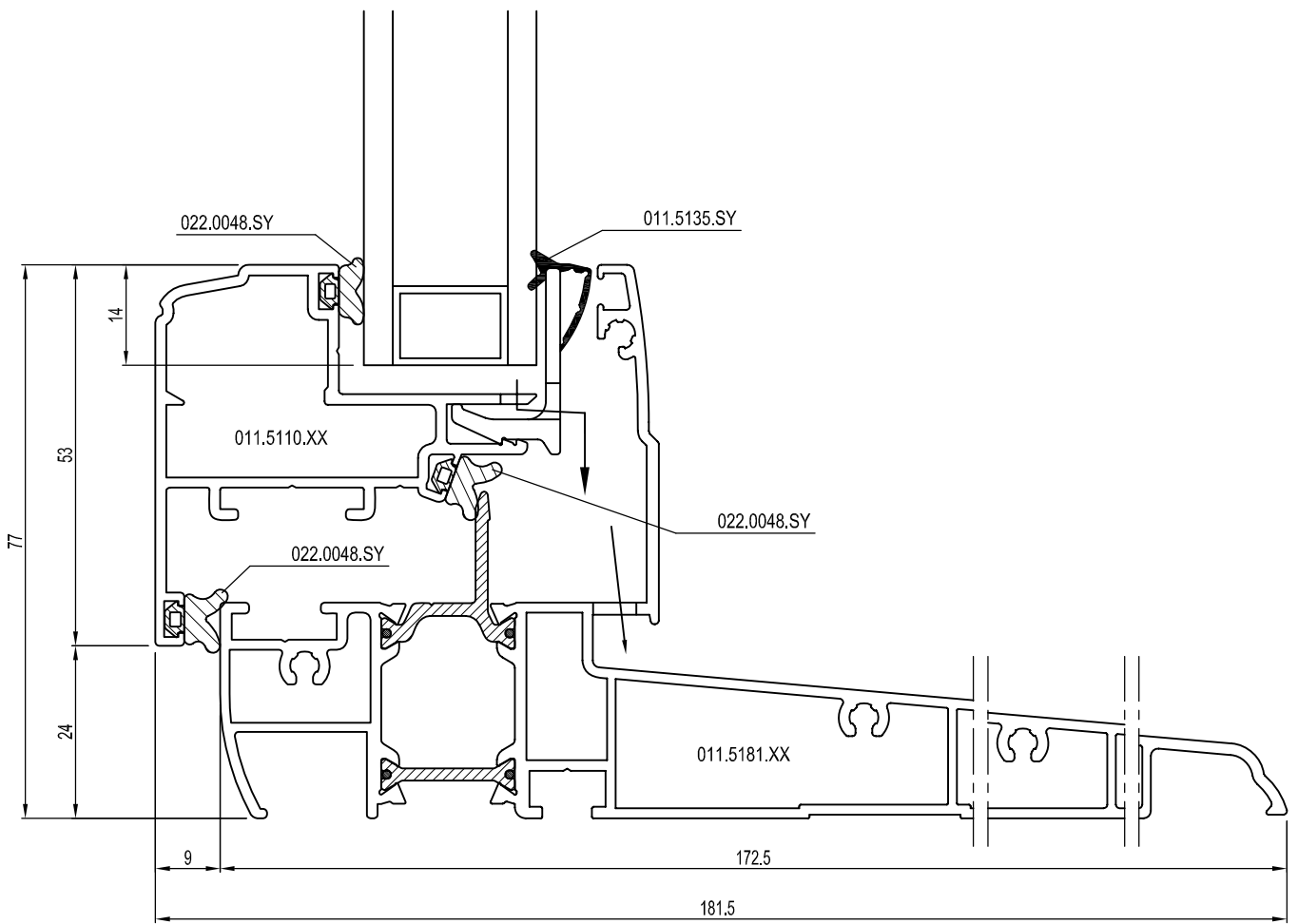
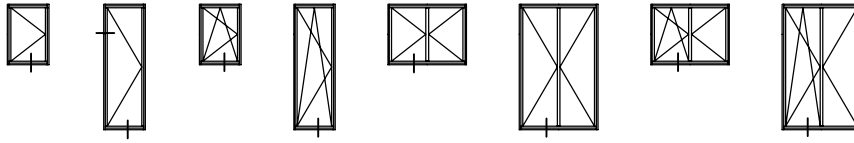

D0035509

DOUBLAGE DE 100 A 160mm / ISOLATION 100 TO 160mm

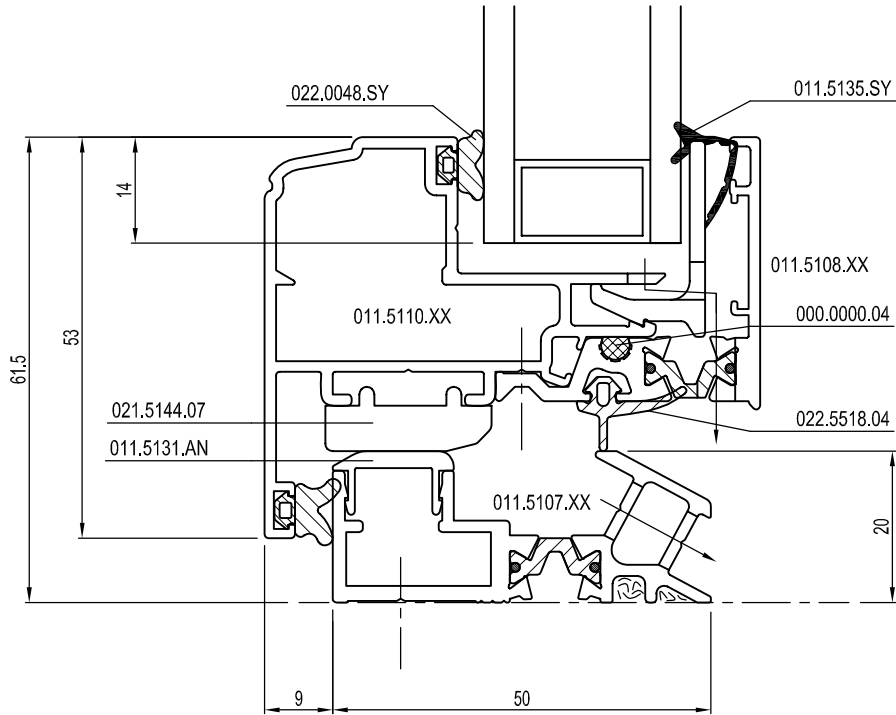
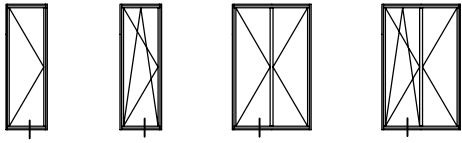

DOUBLAGE DE 100mm / ISOLATION 100mm

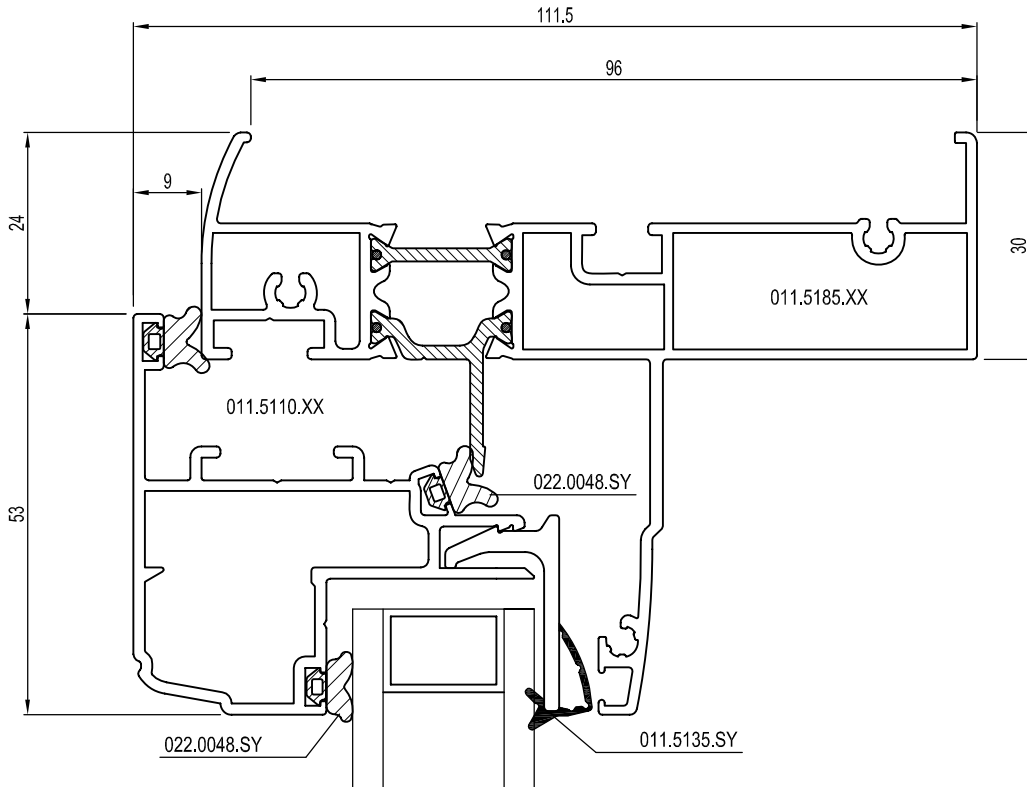
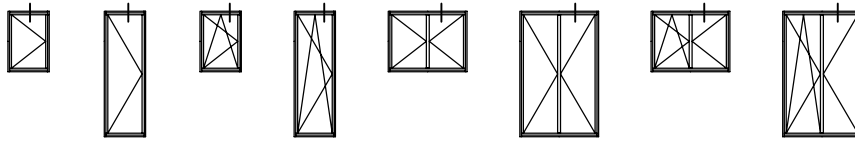

DOUBLAGE DE 120mm / ISOLATION 120mm

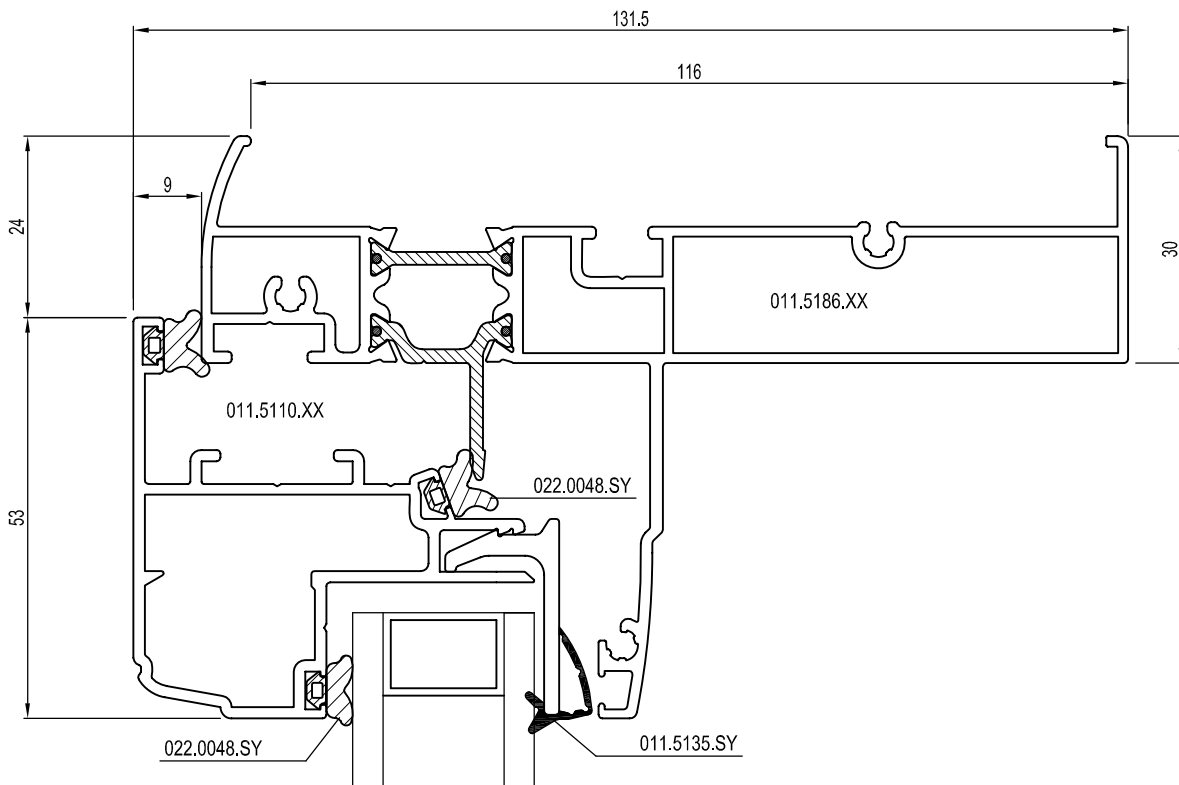

DOUBLAGE DE 140mm / ISOLATION 140mm

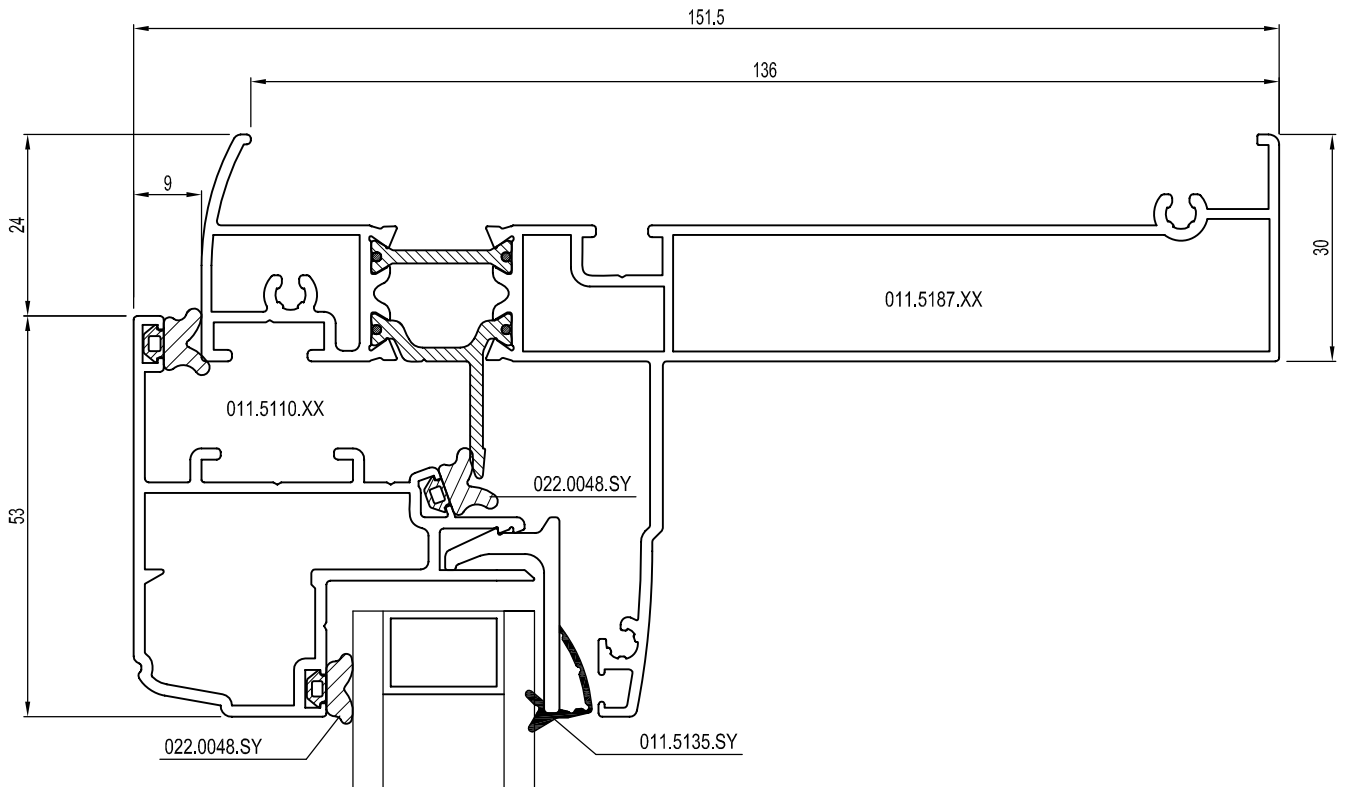
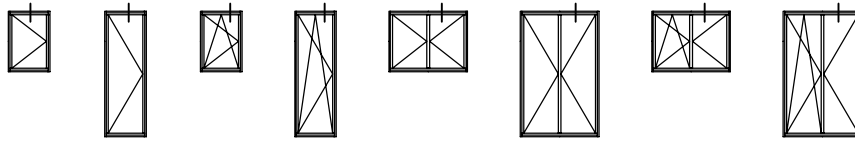

DOUBLAGE DE 160mm / ISOLATION 160mm

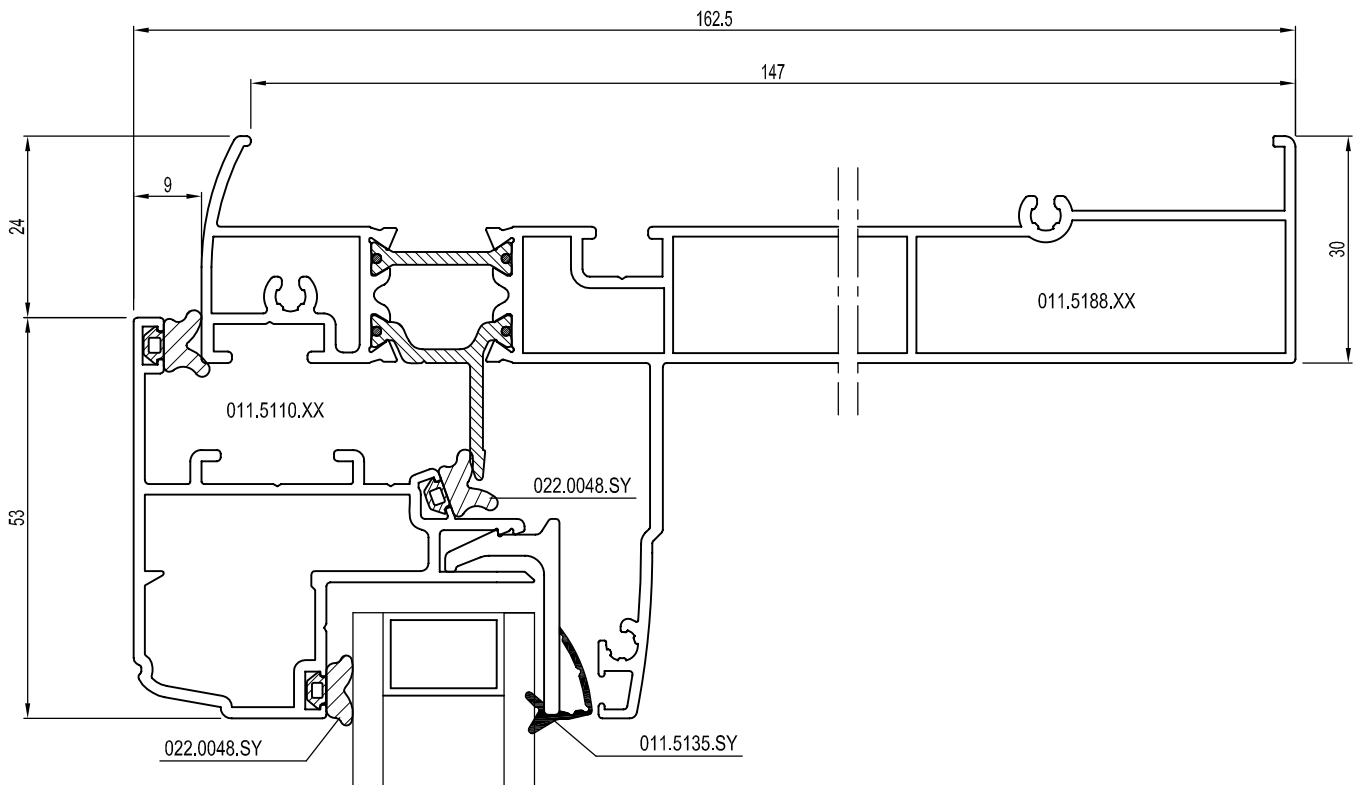

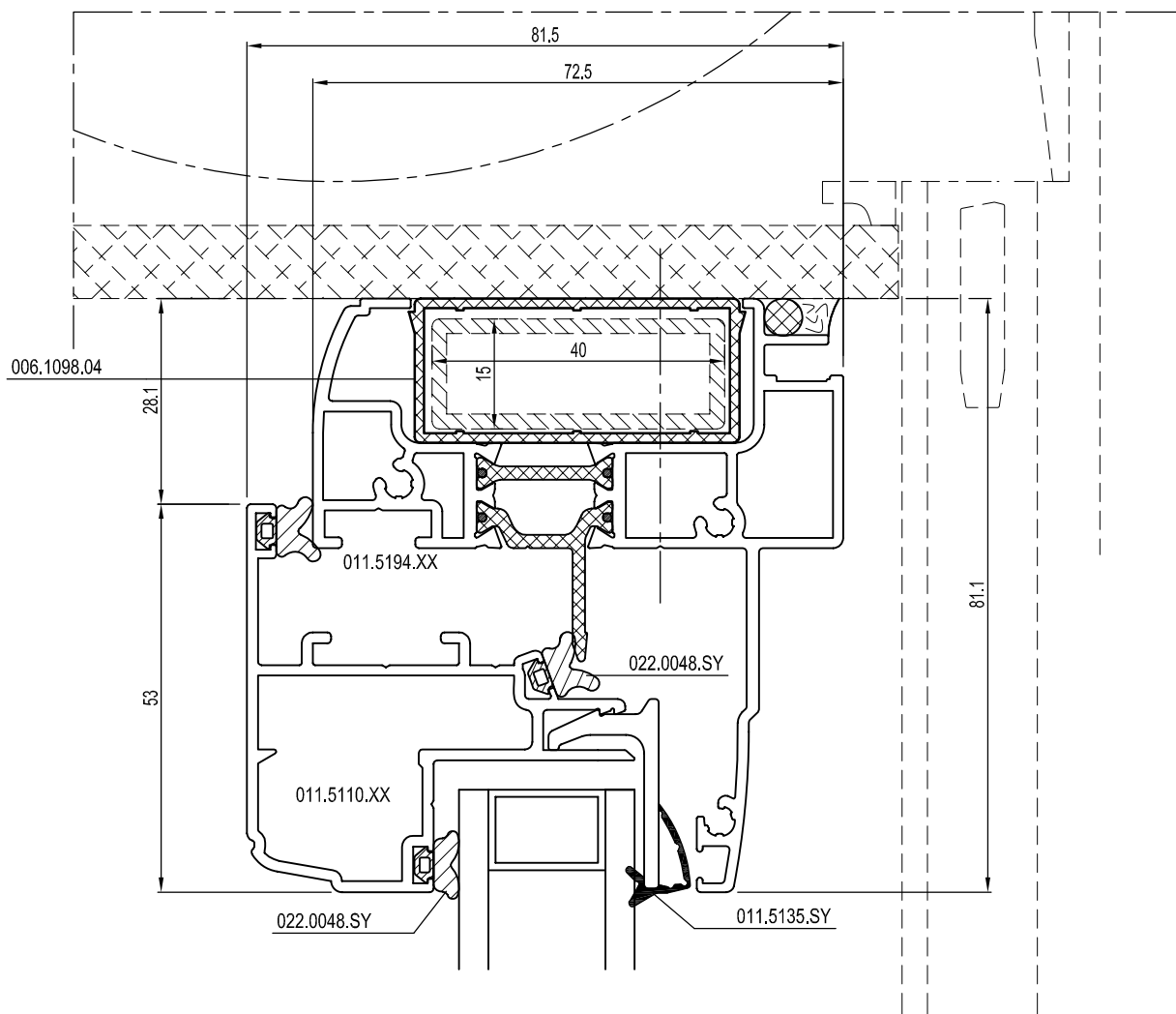
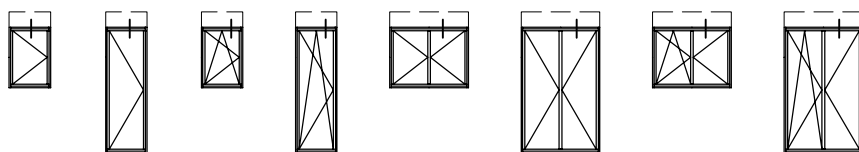

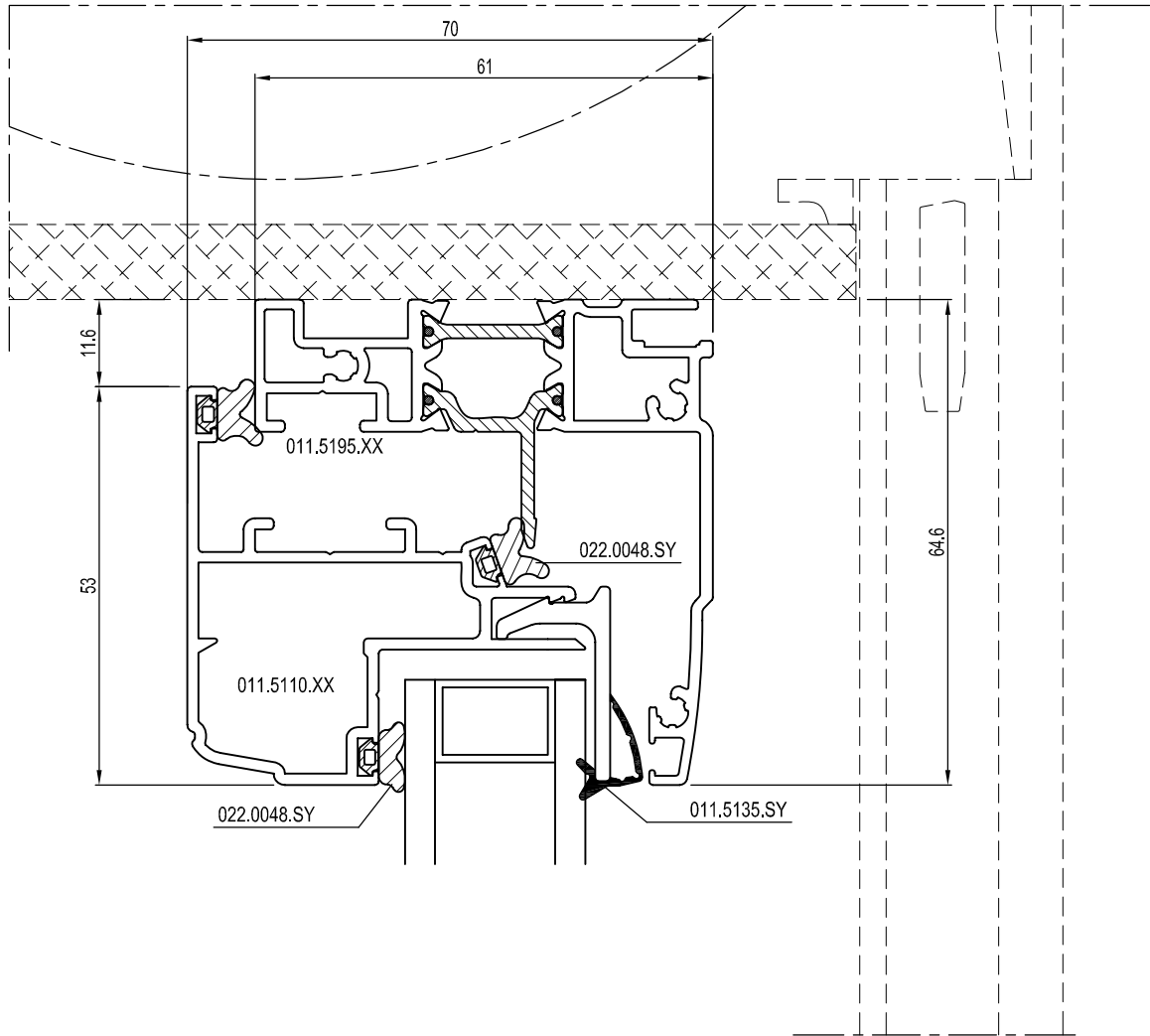
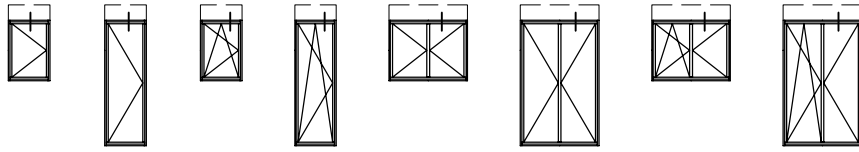

DOUBLAGE DE 100 ET 120mm / ISOLATION 100 AND 120mm

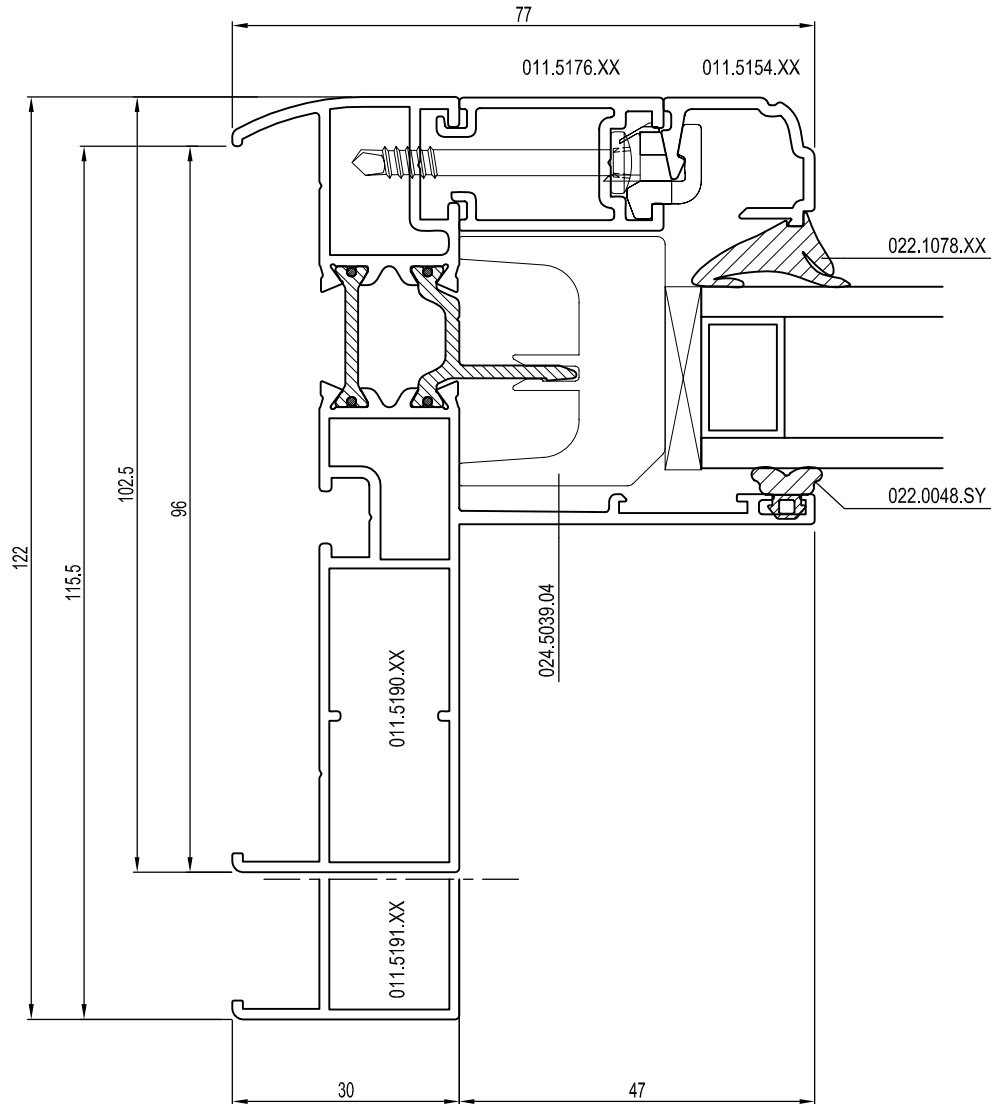
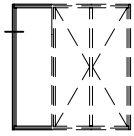

DOUBLAGE DE 100 ET 120mm / ISOLATION 100 AND 120mm

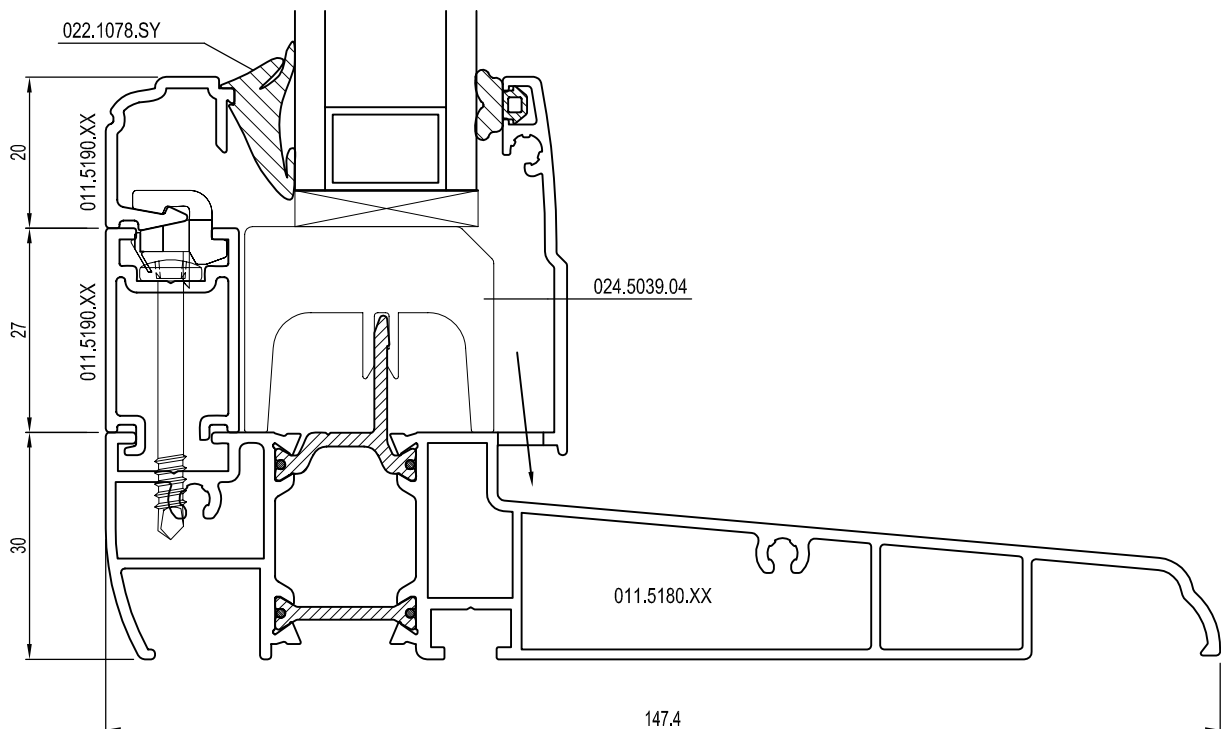
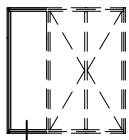
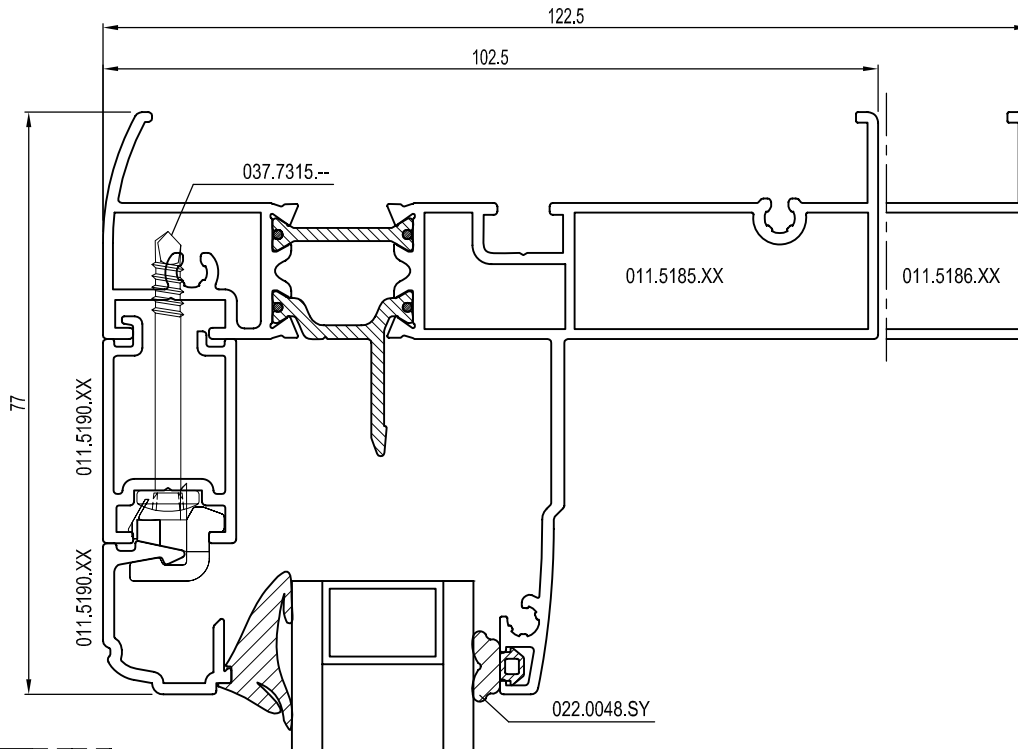
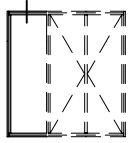

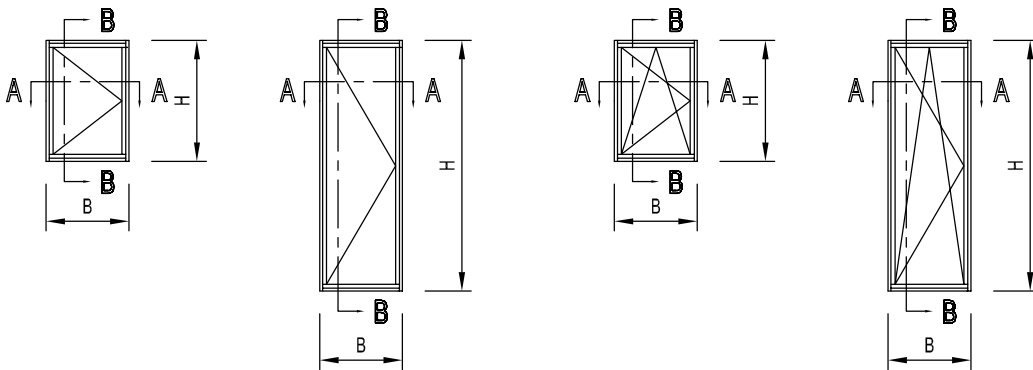

b = B - 126
h = H - 126

A - A

B = Largeur tableau fini + 60

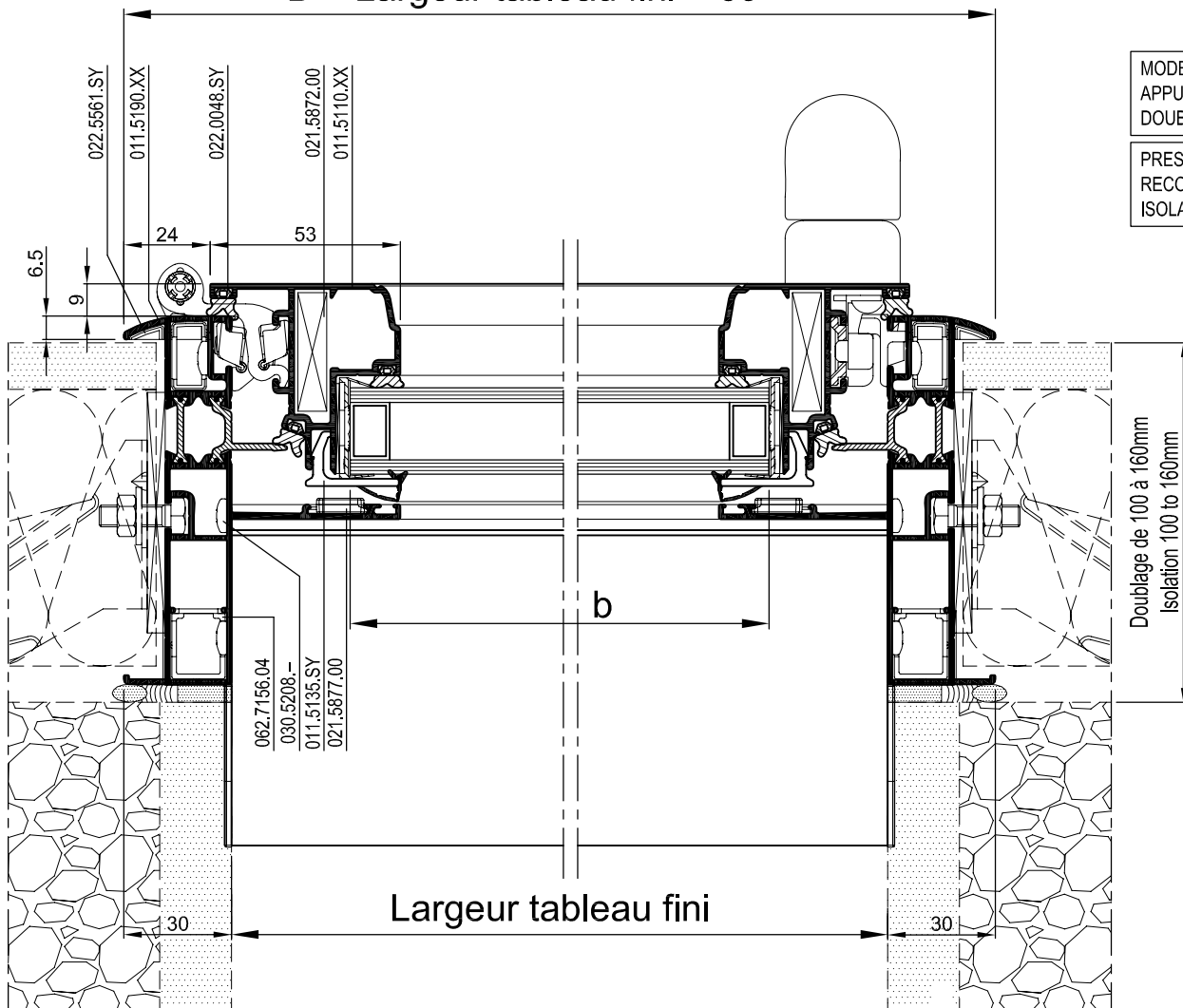

MODELE PRESENTE
APPUI RENTRANT
DOUBLAGE 100 mm

PRESENT MODELE
RECOVER SUPPORT
ISOLATION 100 mm

schaal - échelle
scale - Maßstab
1/2
D0035520

83D.e.002
07/2007

Doublage de 100 a 160mm / Isolation 100 to 160mm

D - D

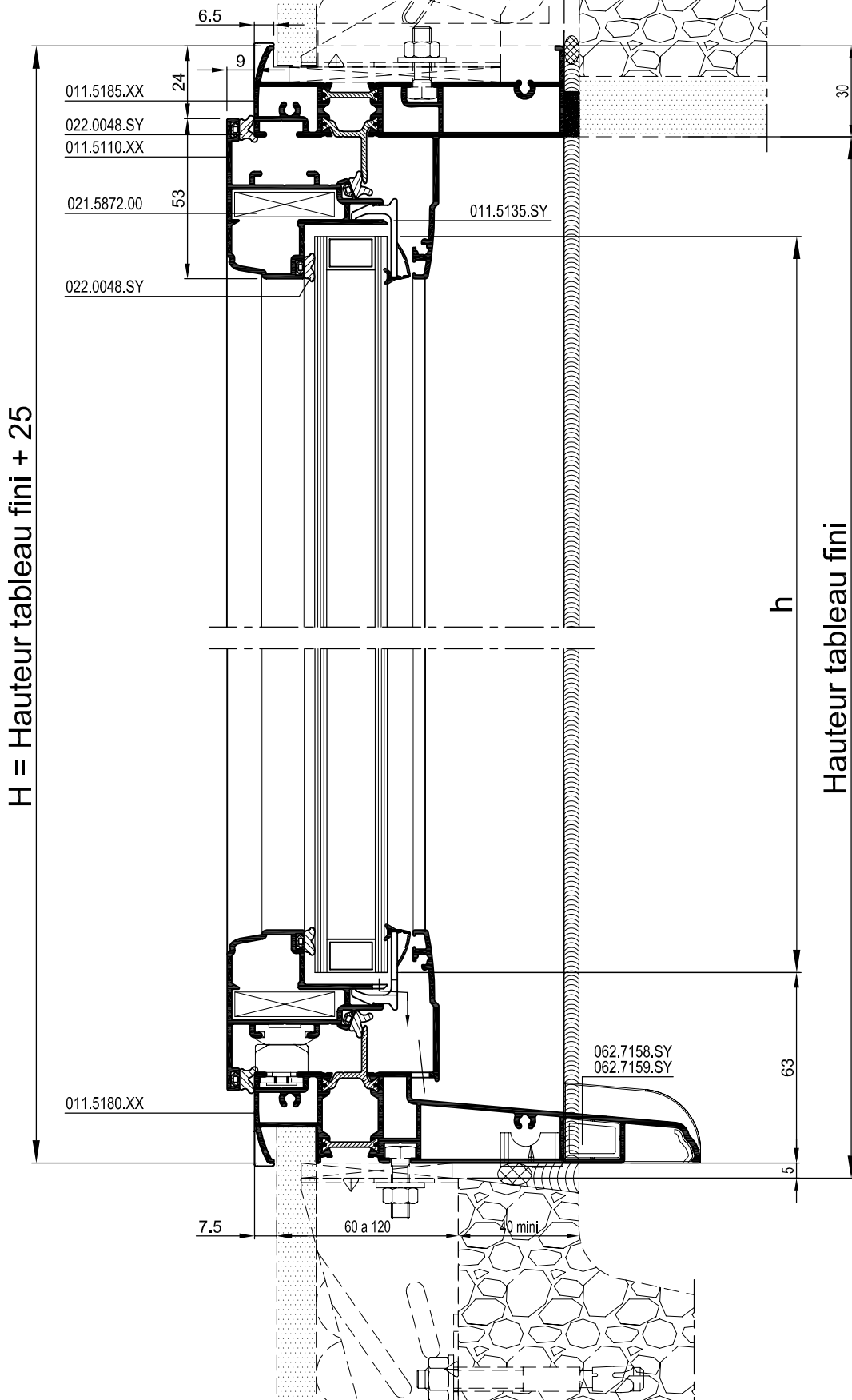

schaal - échelle
scale - Maßstab
1/2

D0035520

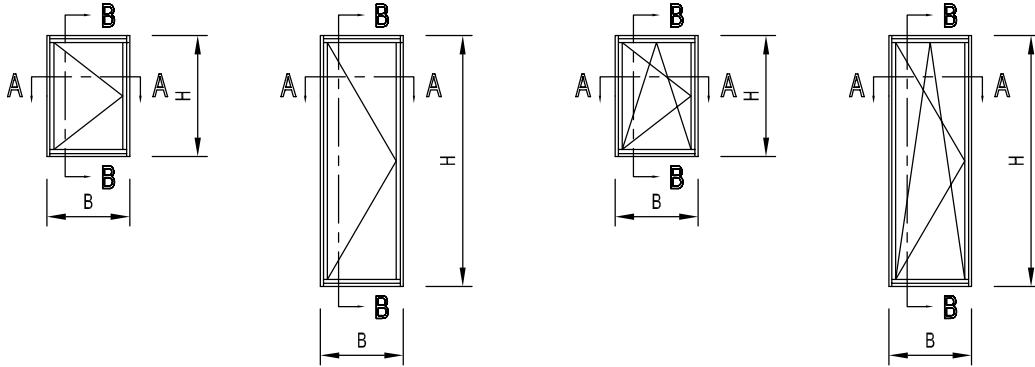

b = B - 126
h = H - 126

A - A

B = Largeur tableau fini + 60

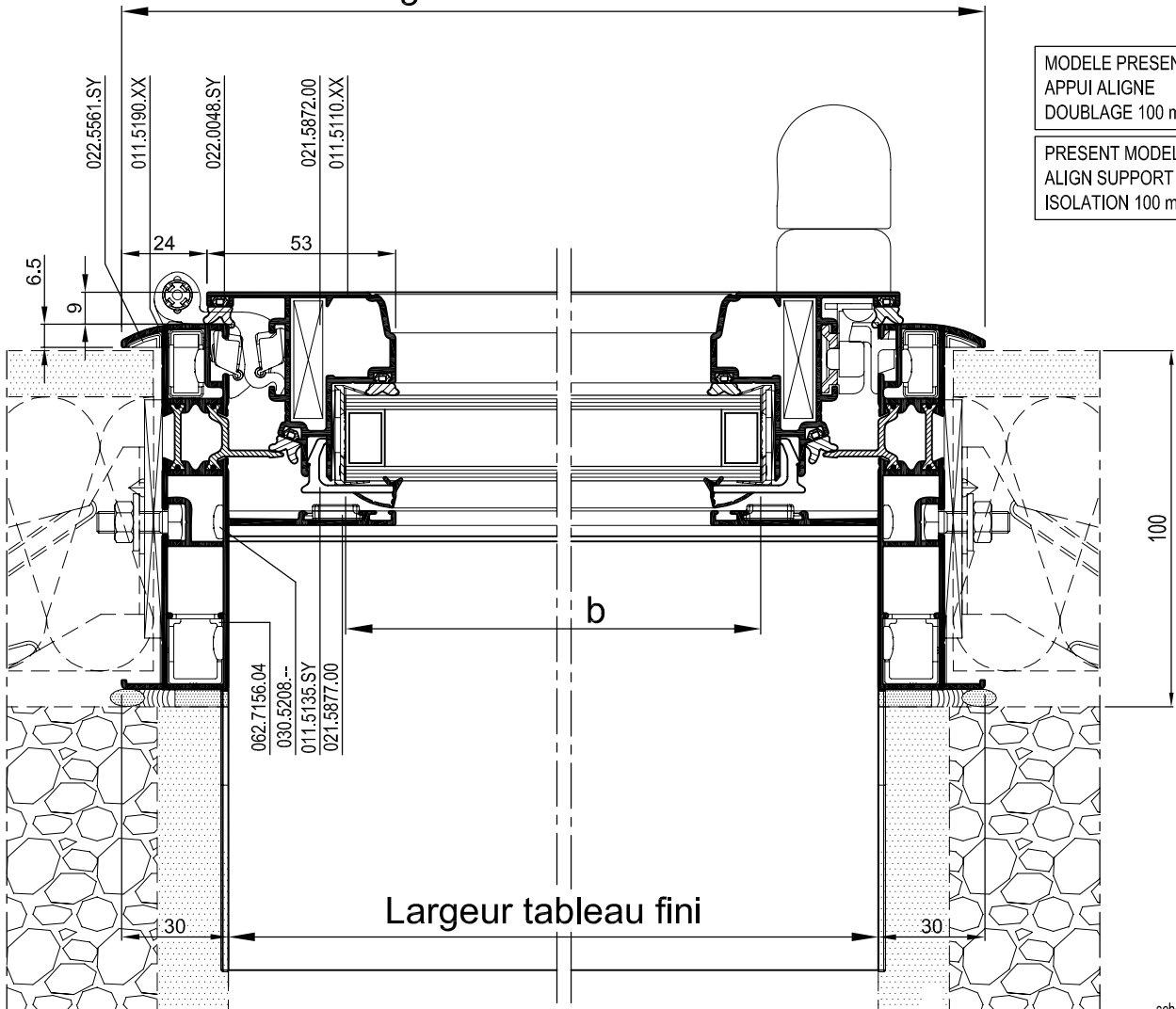

MODELE PRESENTE
APPUI ALIGNE
DOUBLAGE 100 mm

PRESENT MODELE
ALIGN SUPPORT
ISOLATION 100 mm

- 062.7156.04
- 030.5208...
- 011.5135.SY
- 021.5877.00

Largeur tableau fini

schaal - échelle
scale - Maßstab
1/2
D0035523

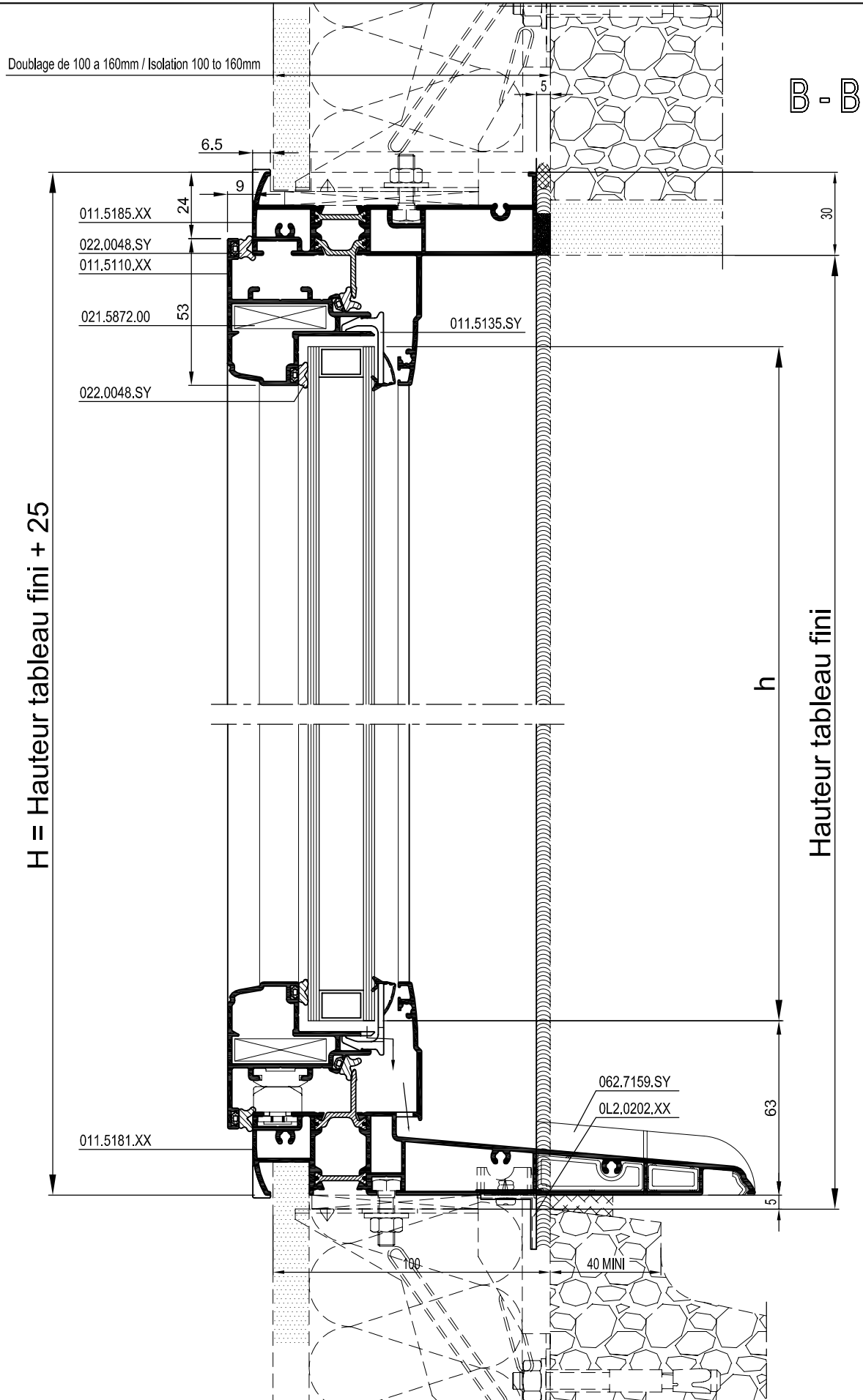

H = Hauteur tableau fini + 25

Hauteur tableau fini

schaal - échelle
scale - Maßstab
1/2

D0035523

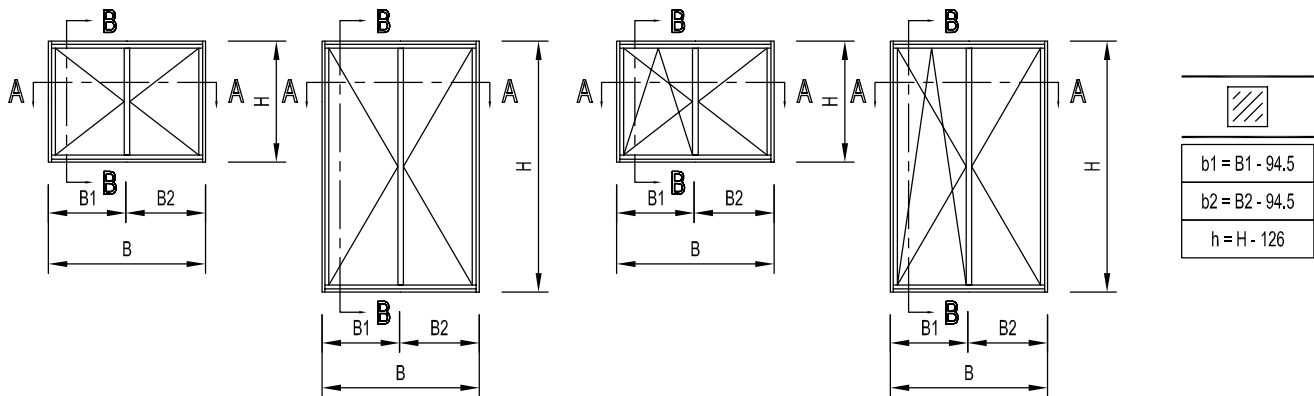

A - A

B = Largeur tableau fini + 60

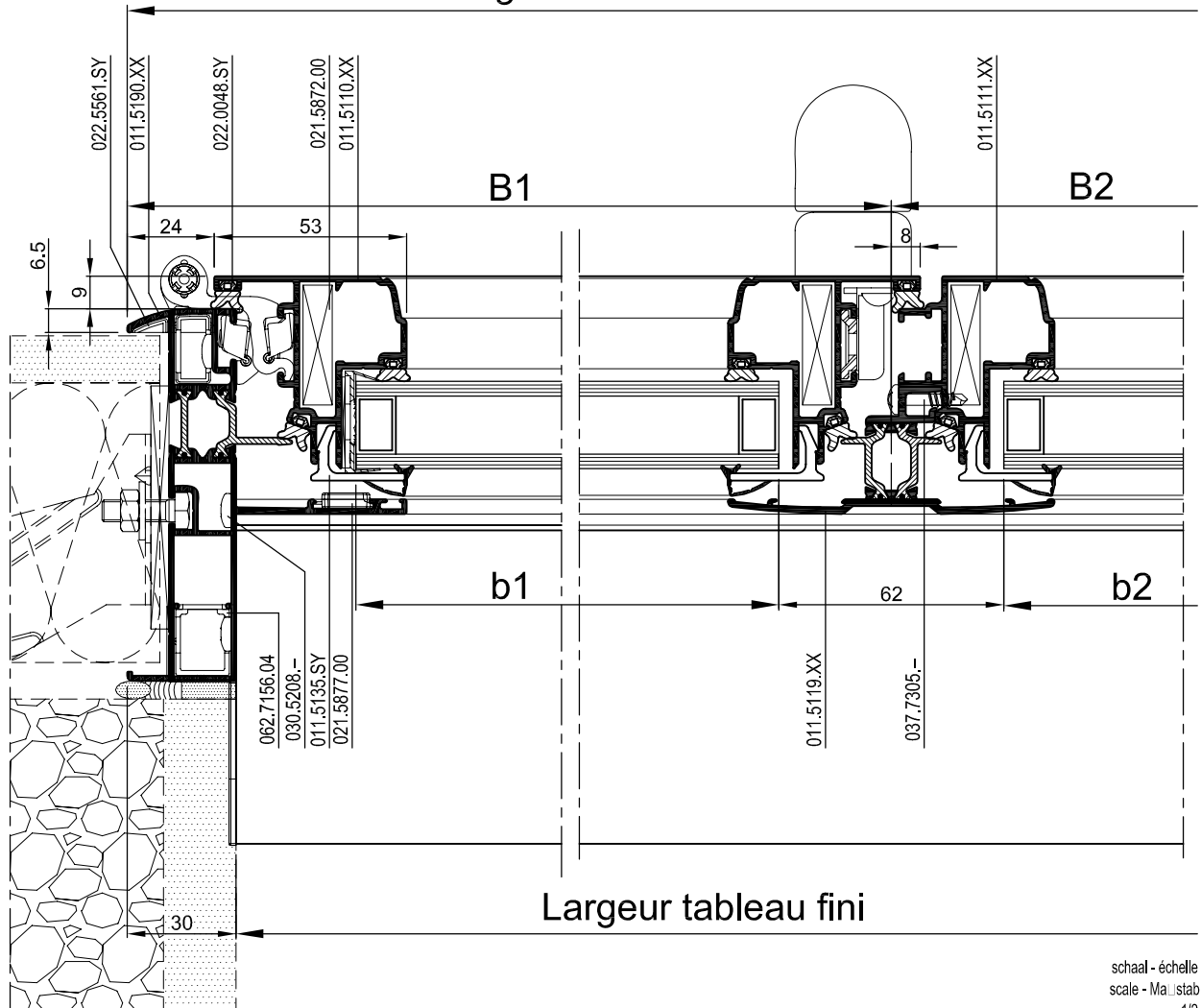

schaal - échelle
scale - Maßstab
1/2

83D.e.014
07/2007

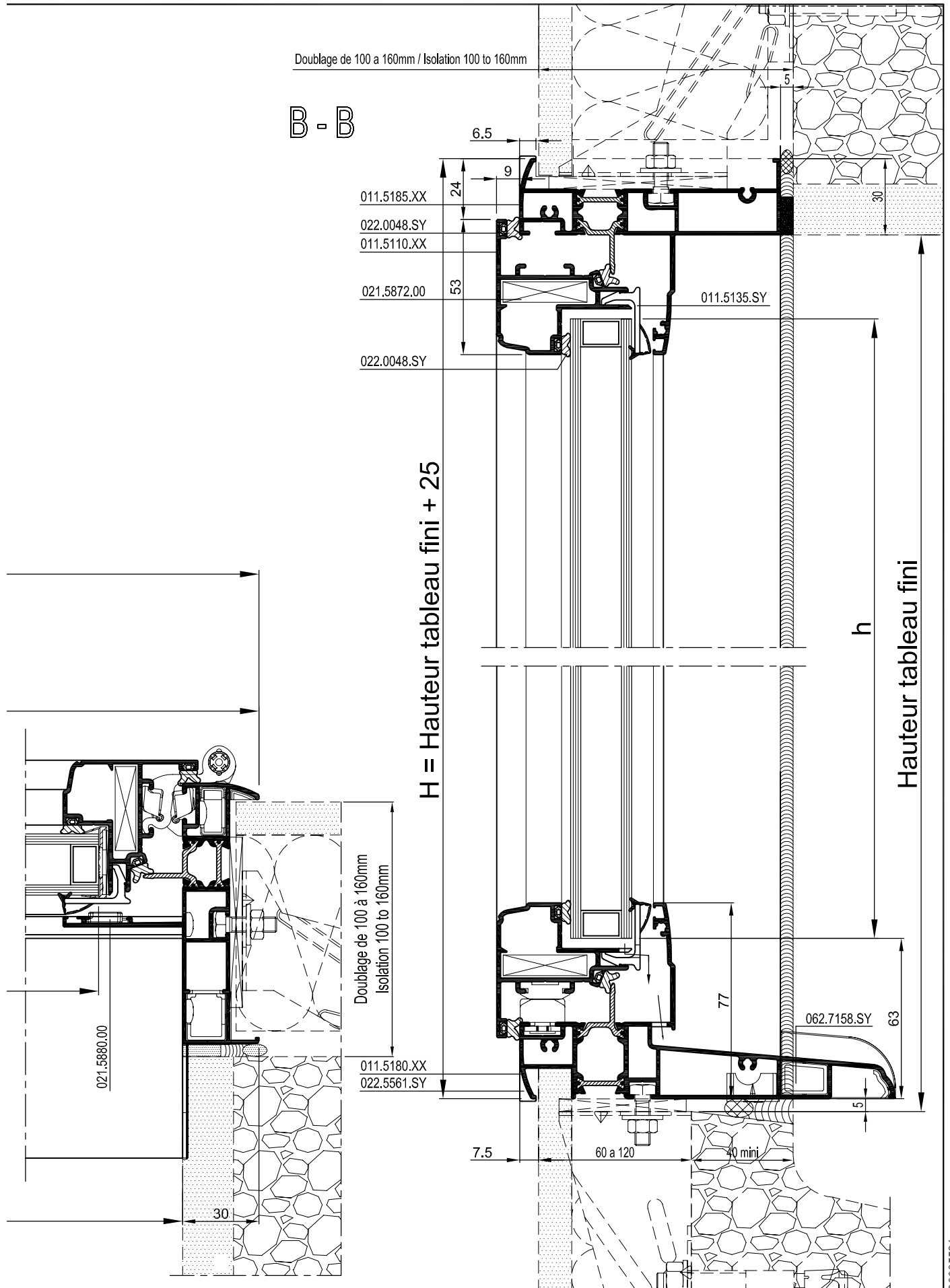

D0035524

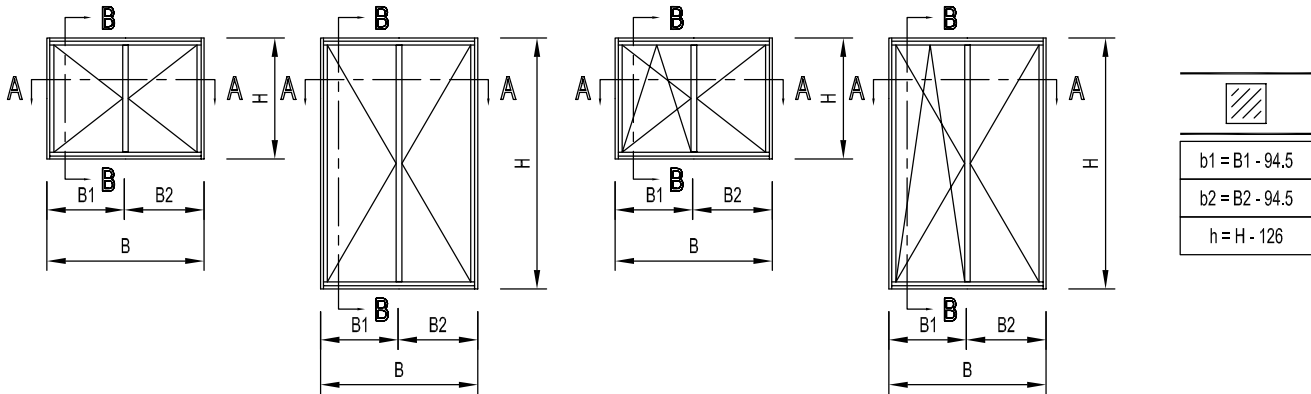

MODELE PRESENTE
APPUI ALIGNE
DOUBLAGE 100 mm

PRESENT MODELE
ALIGN SUPPORT
ISOLATION 100 mm

A - A

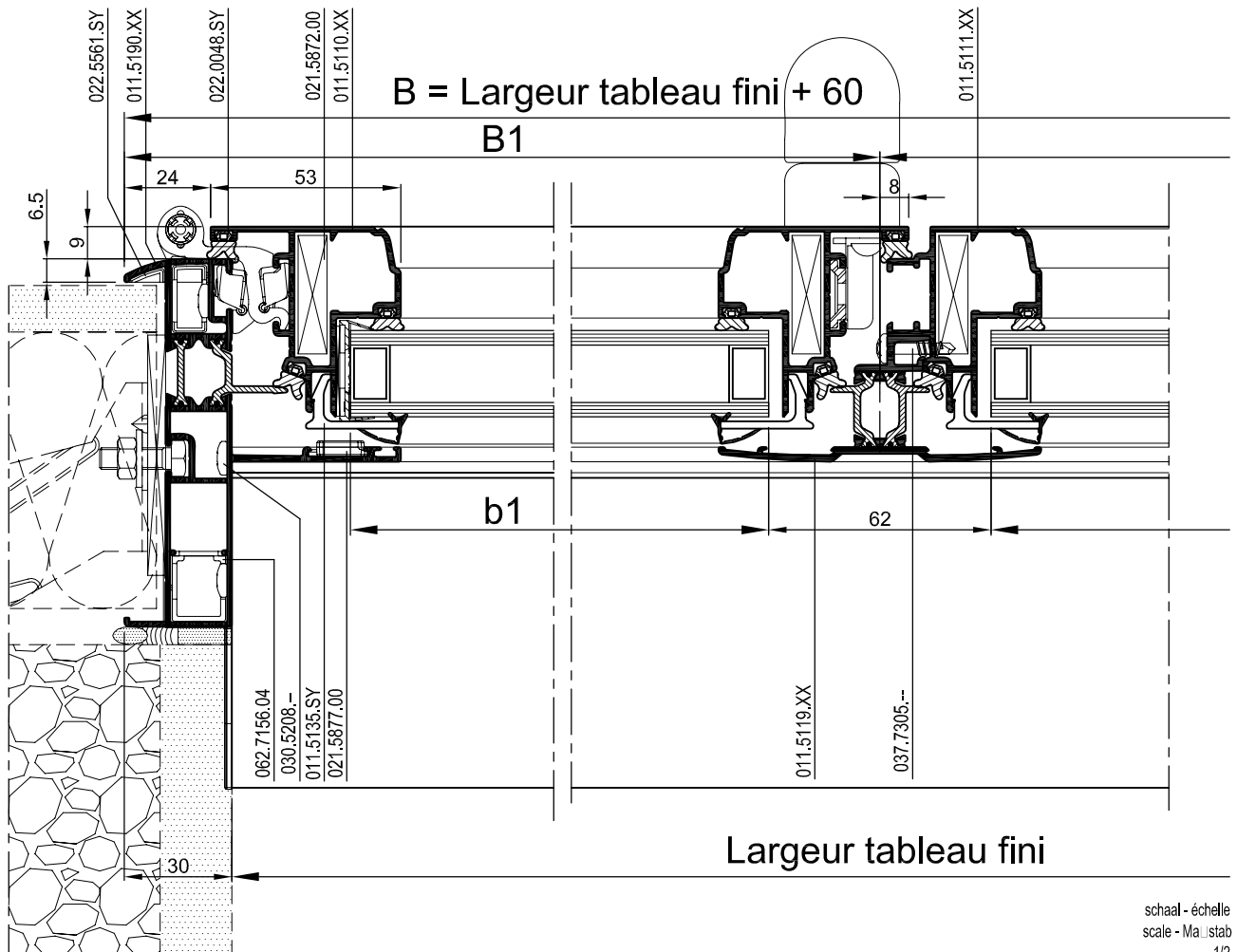

schaal - échelle
scale - Maßstab
1/2
D0035528

83D.e.020
07/2007

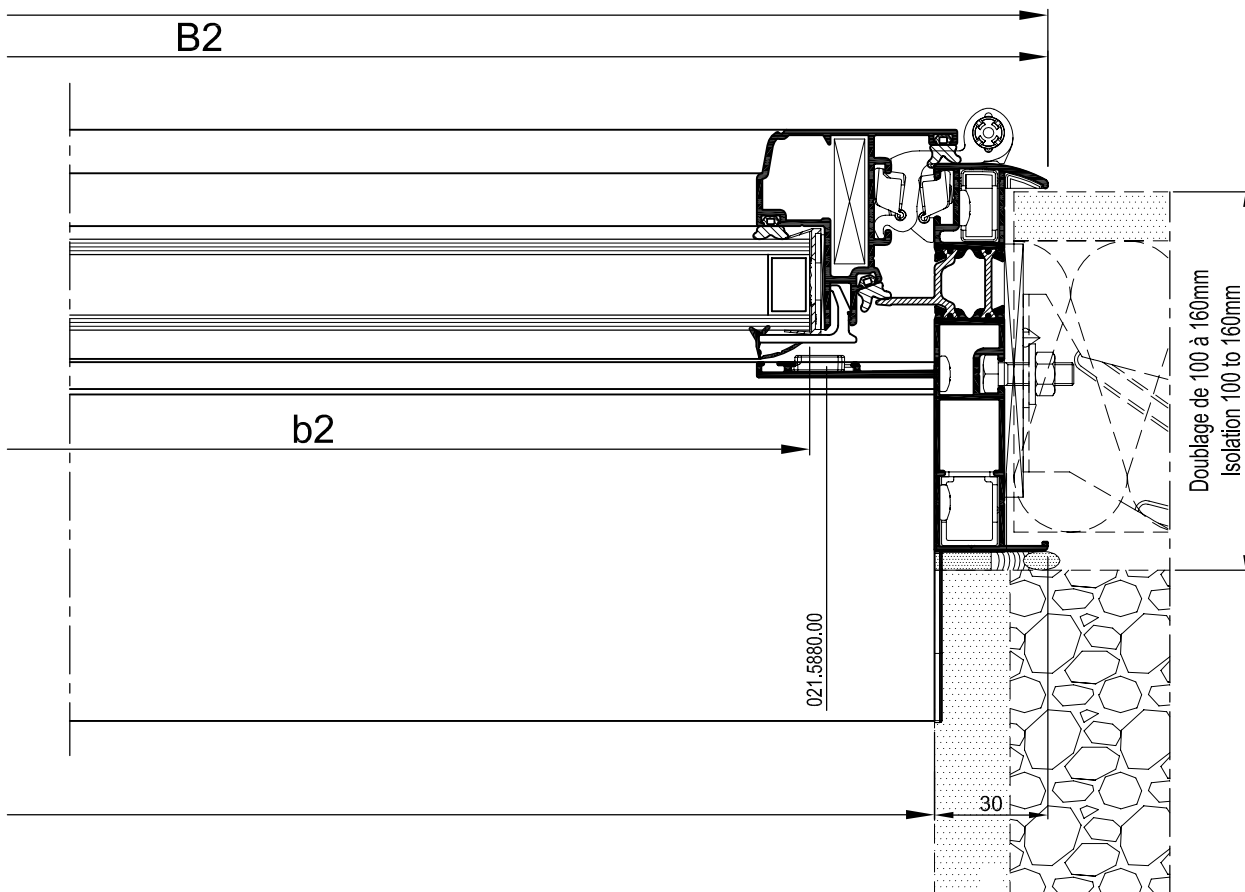

schaal - échelle
scale - Maßstab
1/2

D0035528

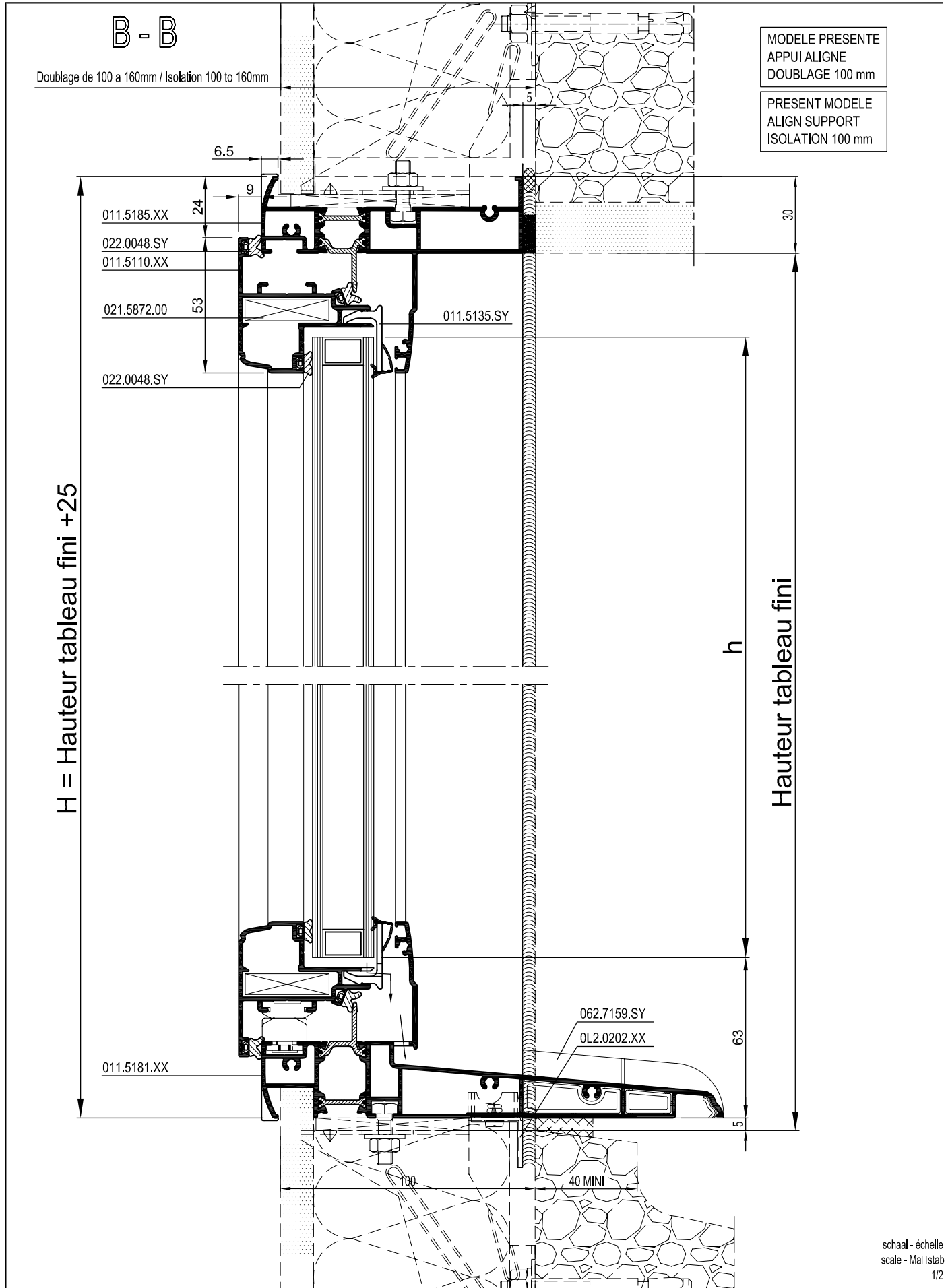

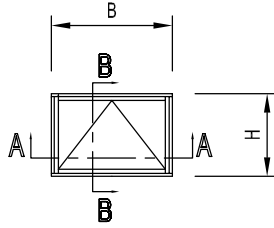

b = B - 126
h = H - 126

MODELE PRESENTE
APPUI RENTRANT
DOUBLAGE 100 mm

PRESENT MODELE
RECOVER SUPPORT
ISOLATION 100 mm

A - A

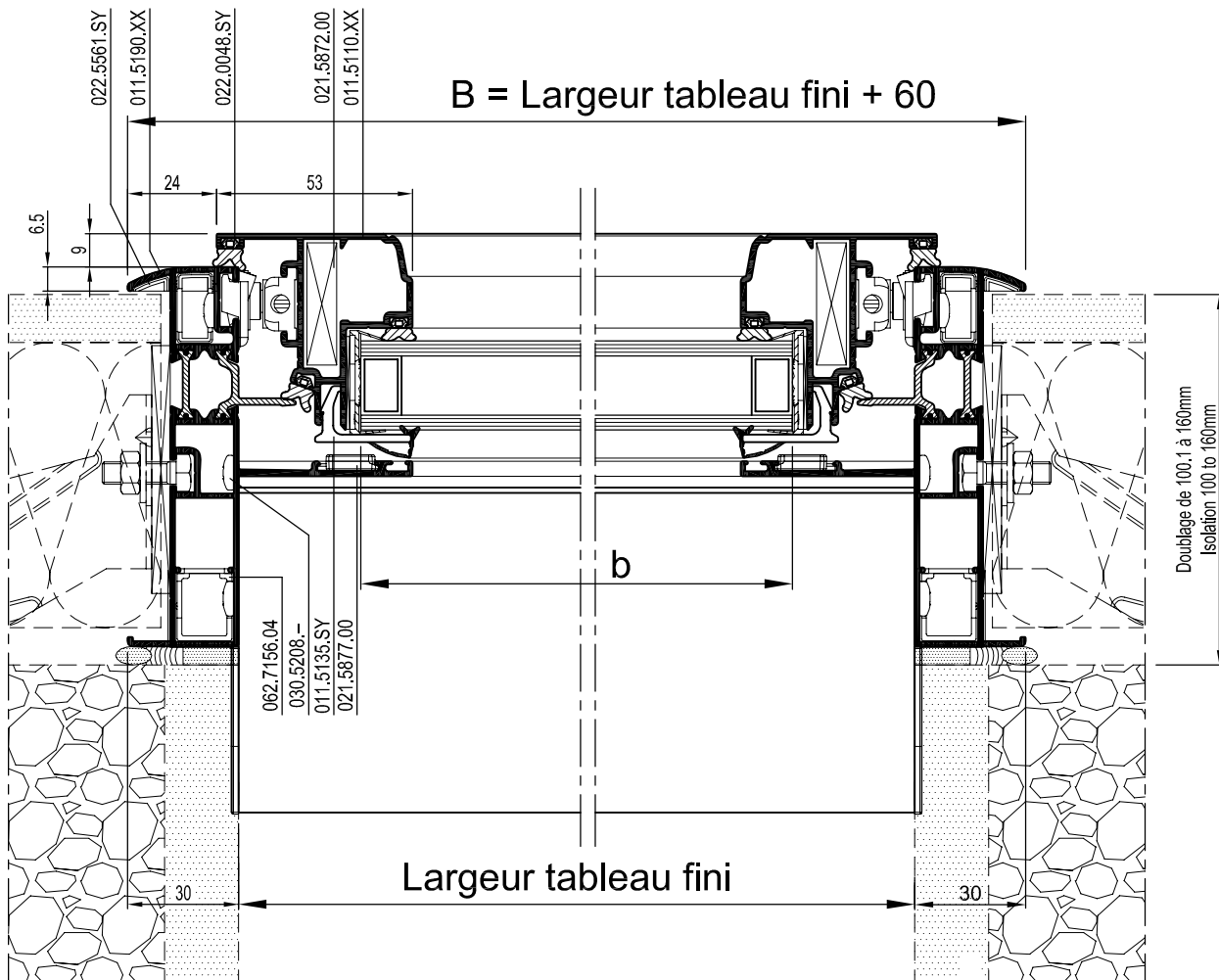

schaal - échelle
scale - Maßstab
1/2
D0035530

83D.e.028
07/2007

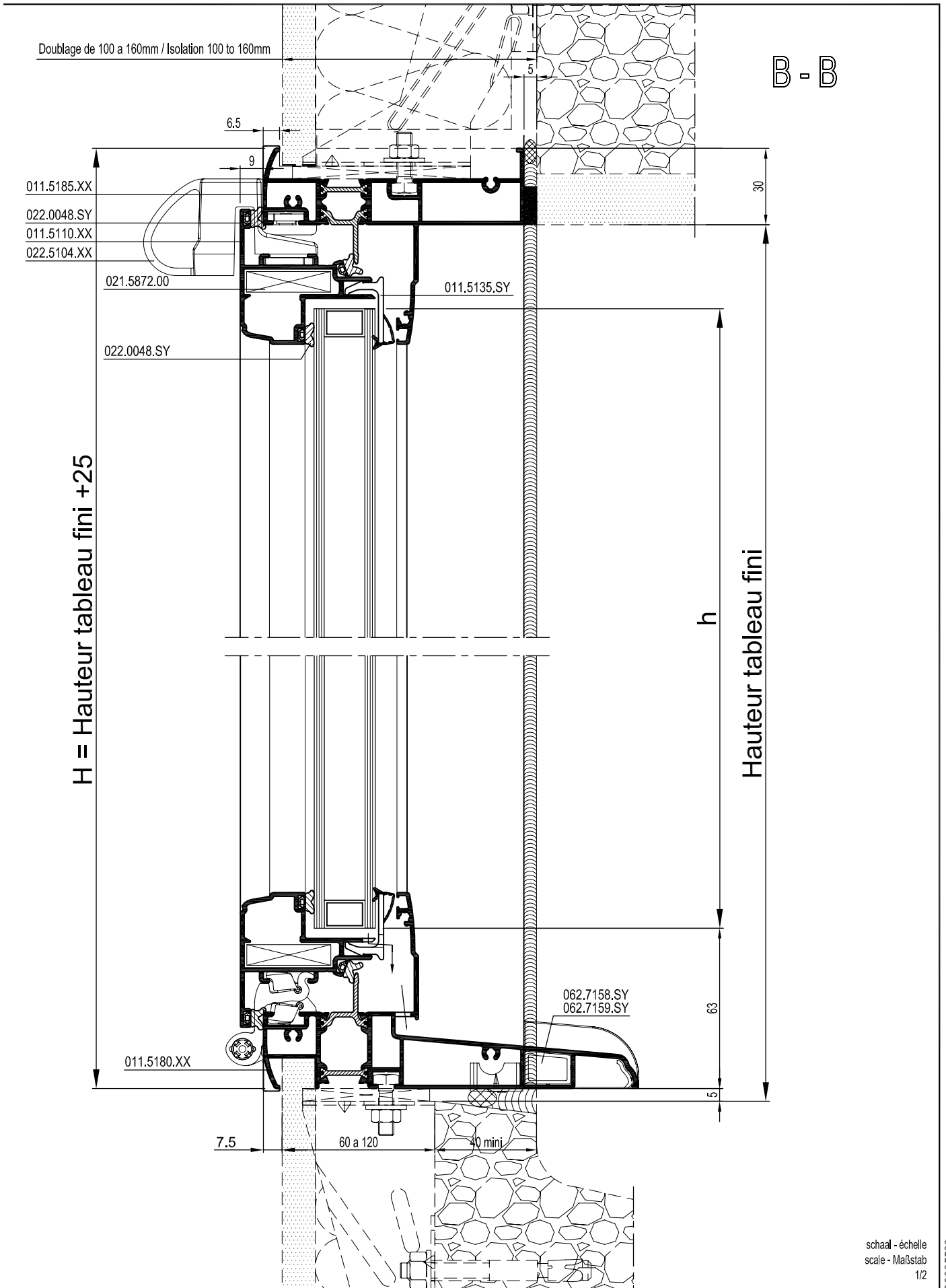

schaal - échelle
scale - Maßstab
1/2

D0035530

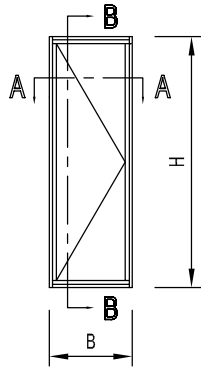

b = B - 126
h = H - 110.5

MODELE PRESENTE
DOUBLAGE 100 mm
PRESENT MODELE
ISOLATION 100 mm

A - A

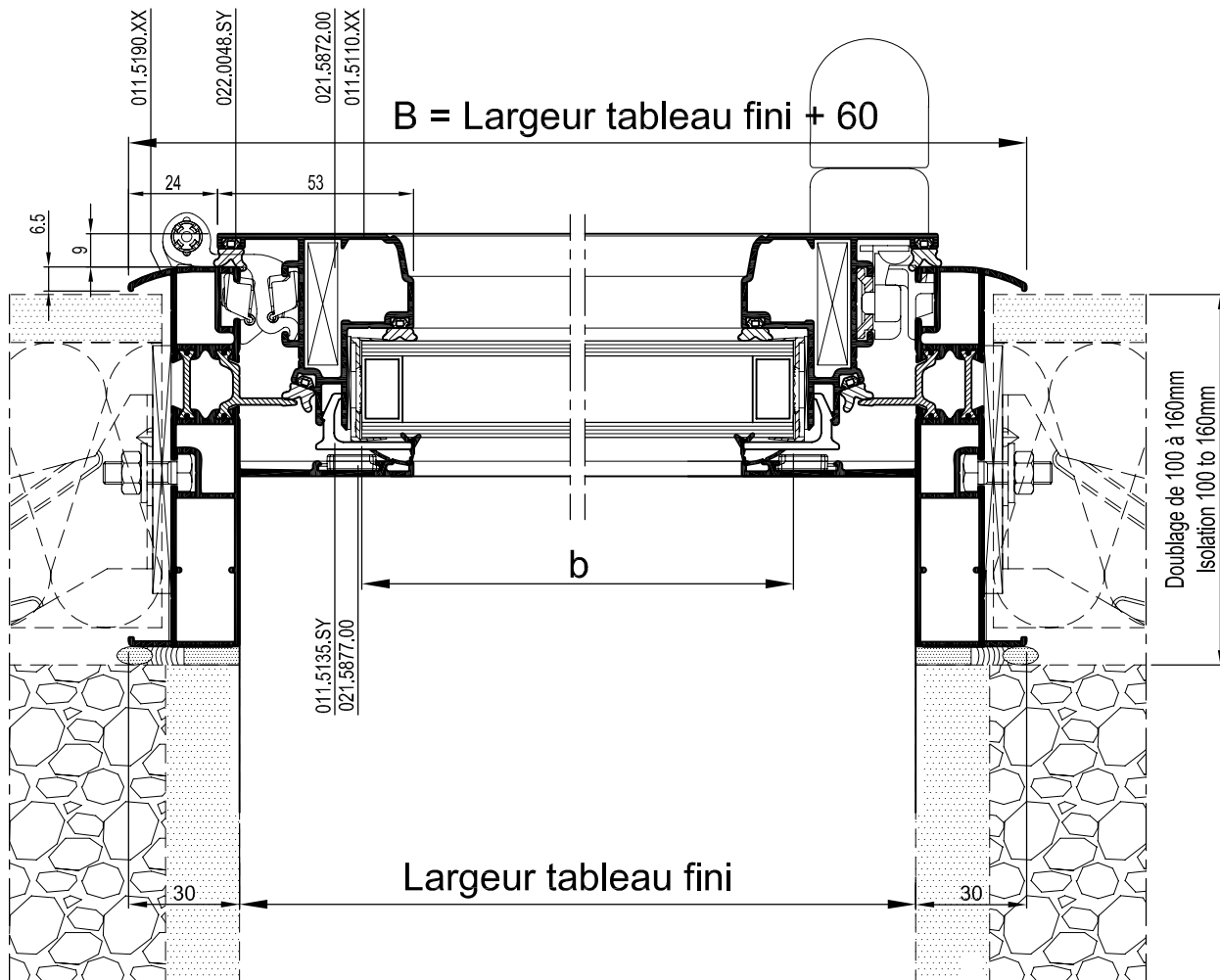

schaal - échelle
scale - Maßstab
1/2

83D.e.034
07/2007

Doublage de 100 a 160mm / Isolation 100 to 160mm

B - B

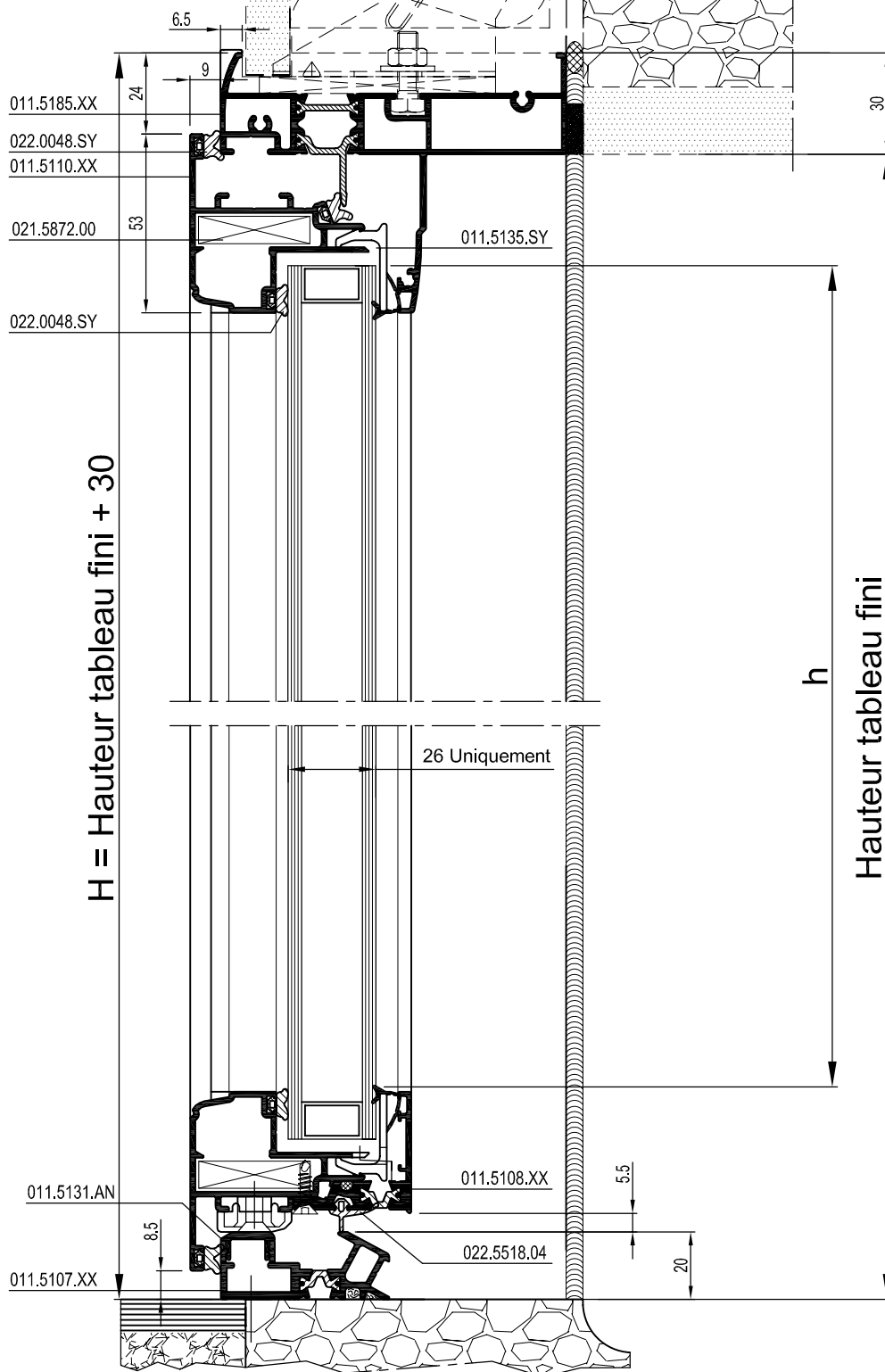

H = Hauteur tableau fini + 30

Hauteur tableau fini

26 Uniquement

schaal - échelle
scale - Maßstab
1/2

D0035533

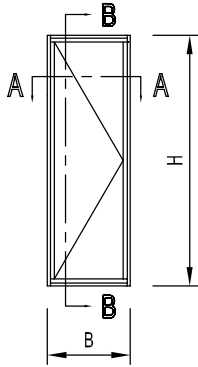

	Remplissage de 26mm uniquement Glazing 26mm only
b = B - 190,5	
h = H - 110,5	

MODELE PRESENTE
DOUBLAGE 100 mm
PRESENT MODELE
ISOLATION 100 mm

A - A

B = Largeur tableau fini + 60

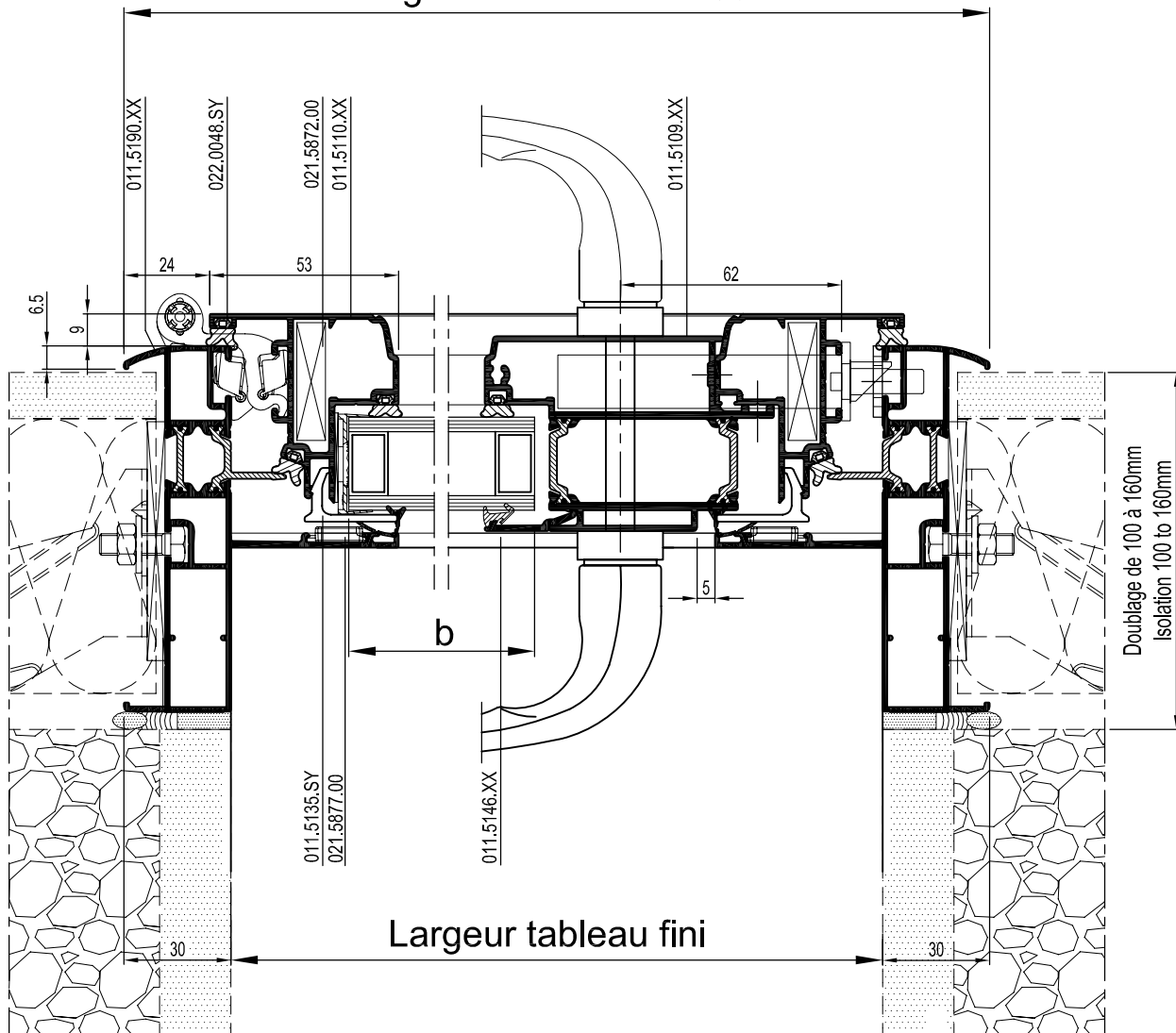

schaal - échelle
scale - Maßstab
1/2
D0035536

83D.e.040
07/2007

Doublage de 100 a 160mm / Isolation 100 to 160mm

B - B

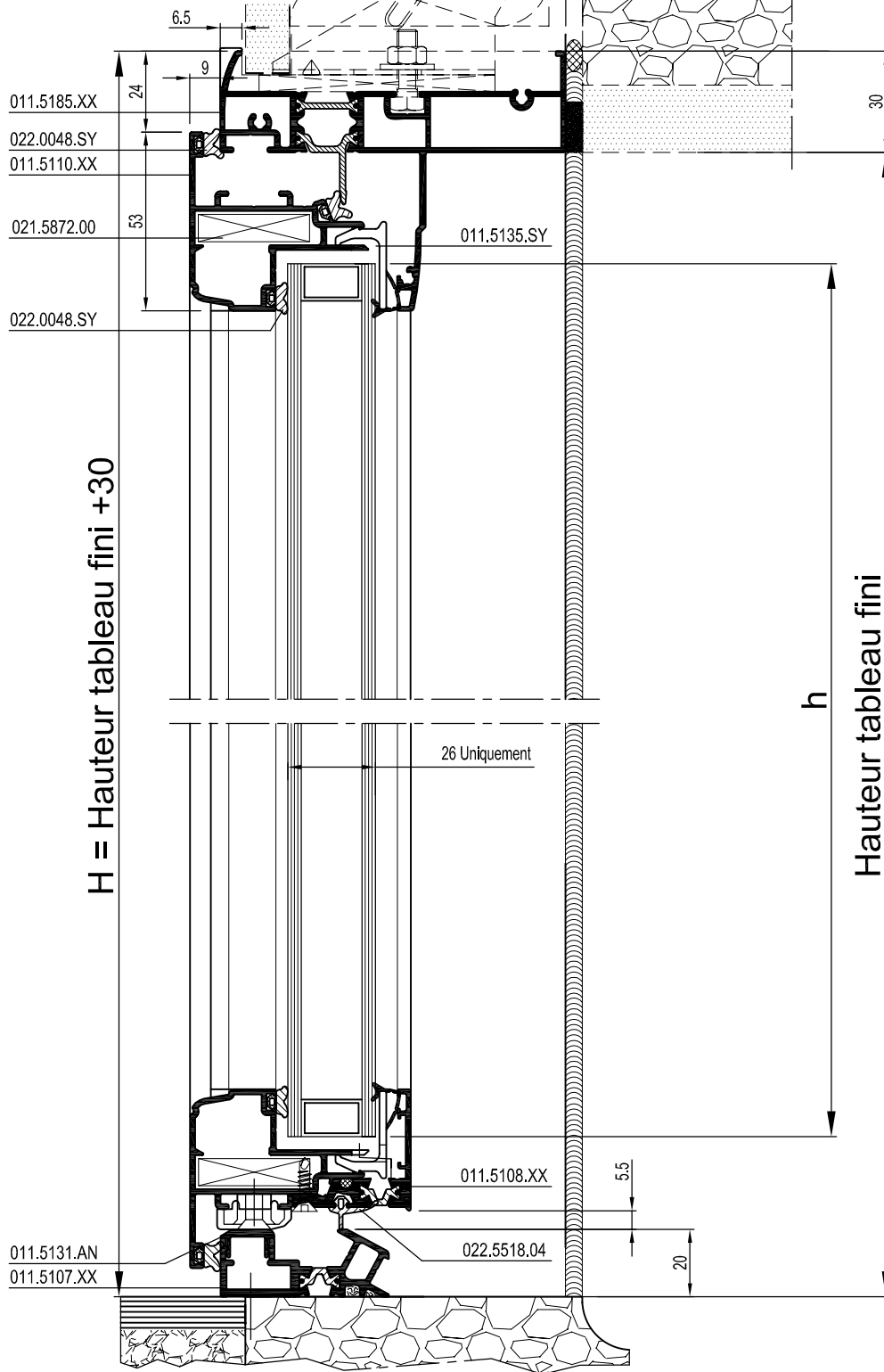

schaal - échelle
scale - Maßstab
1/2

D003536

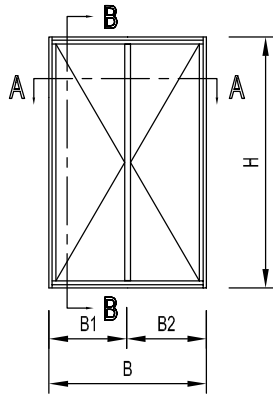

b1 = B1 - 94,5
b2 = B2 - 94,5
h = H - 110,5

MODELE PRESENTE
DOUBLAGE 100 mm
PRESENT MODELE
ISOLATION 100 mm

A - A

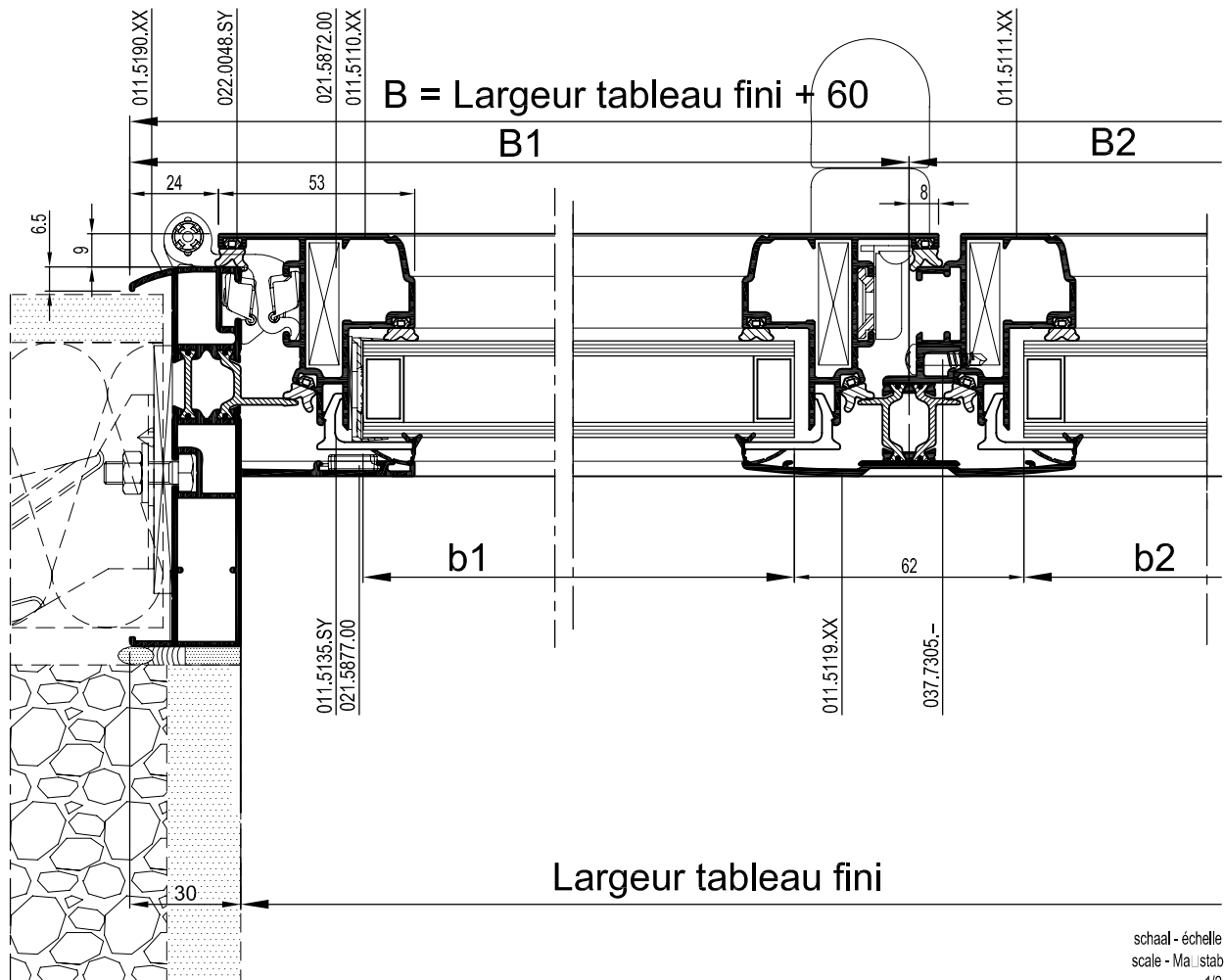

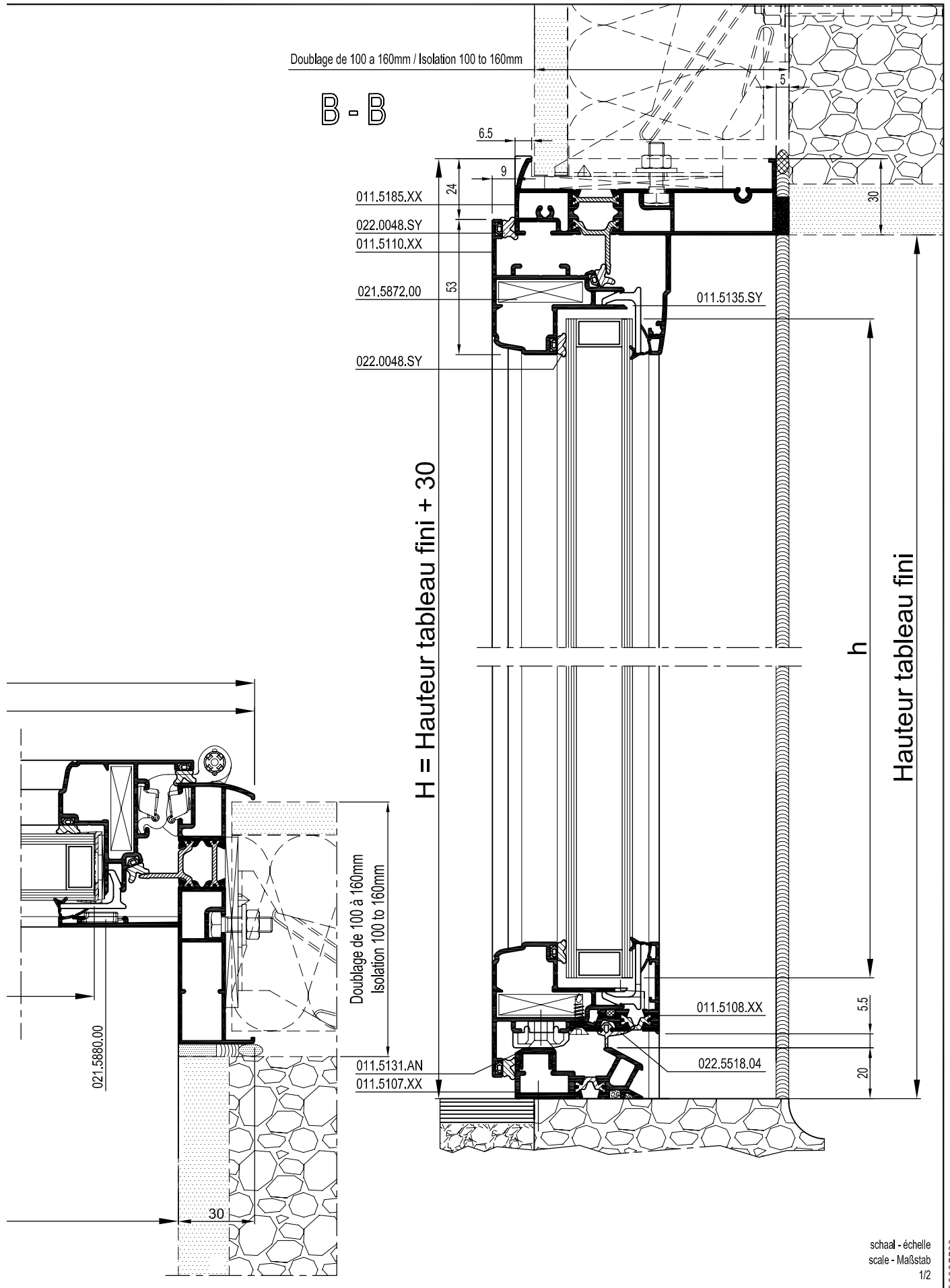

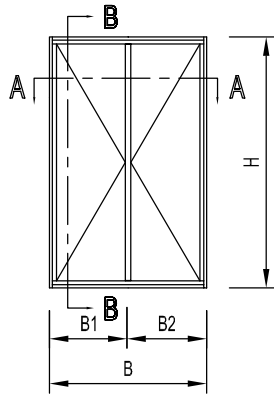

b1 = B1 - 159
b2 = B2 - 94.5
h = H - 110.5

MODELE PRESENTE
DOUBLAGE 100 mm
PRESENT MODELE
ISOLATION 100 mm

A - A

B = Largeur tableau fini + 60

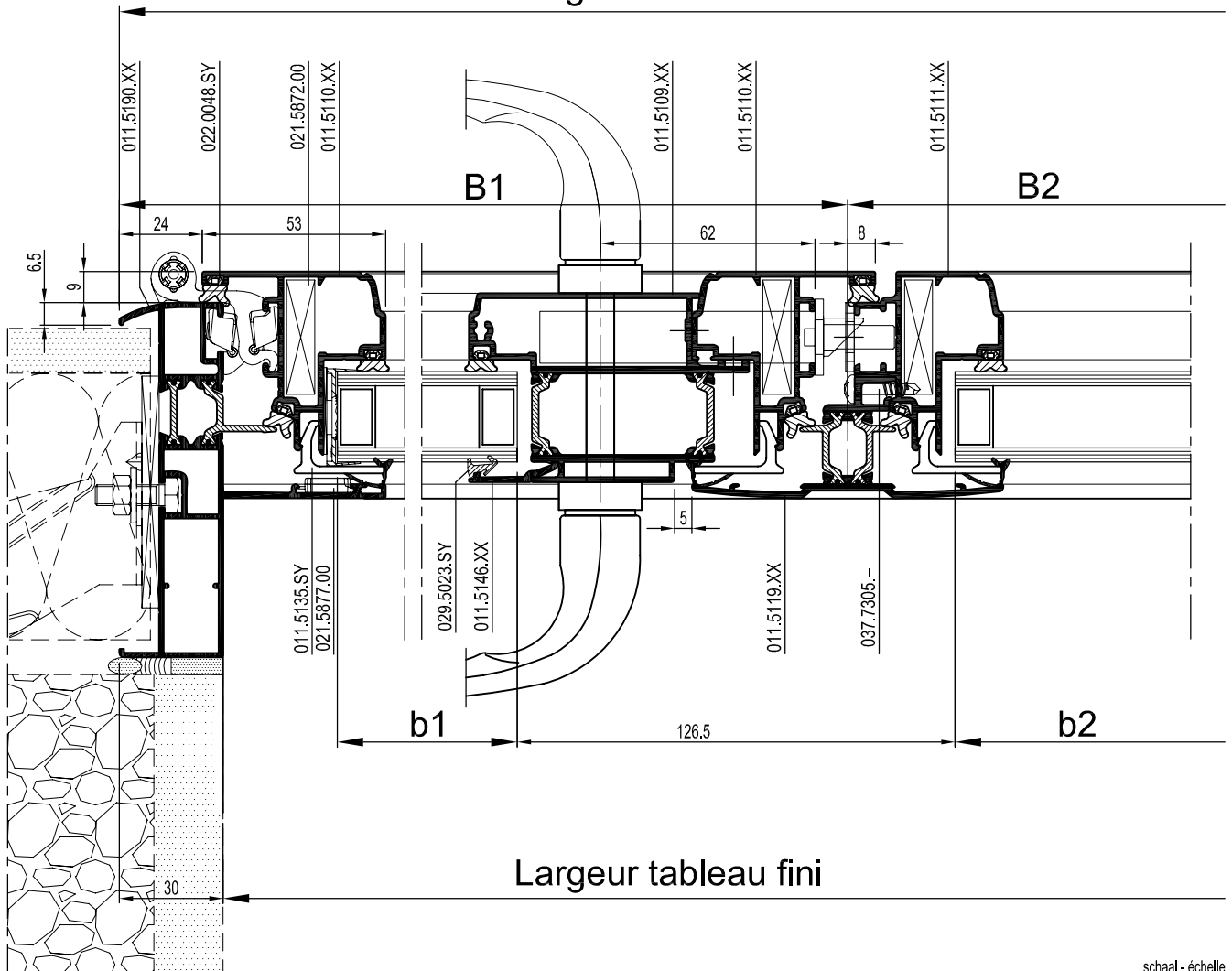

Largeur tableau fini

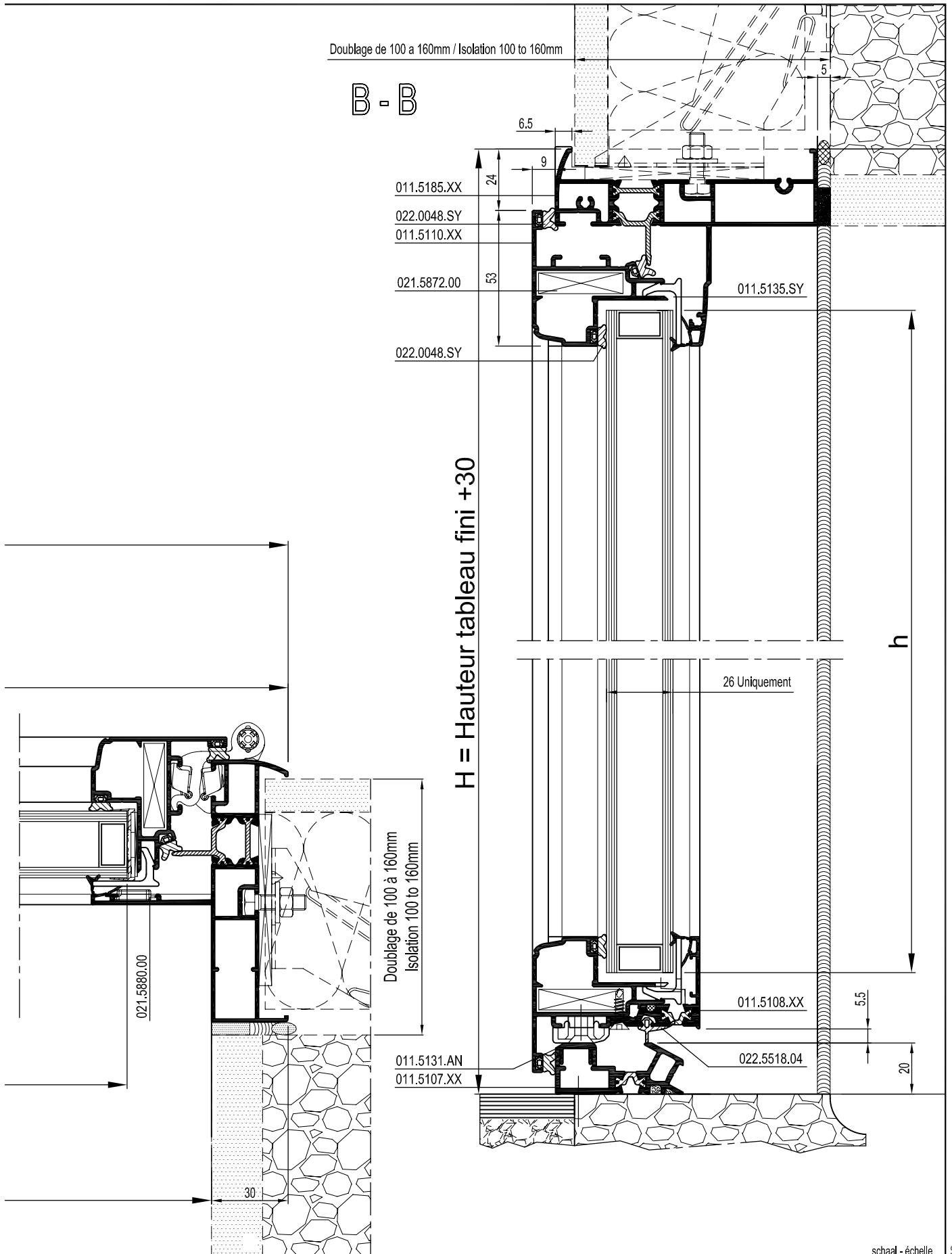

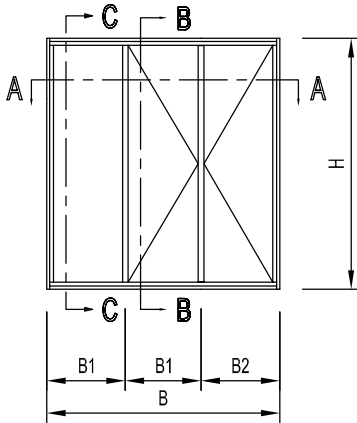

b1 = B1 - 92
b2 = B2 - 62.5
b3 = B3 - 94.5
h = H - 126
h1 = H - 124

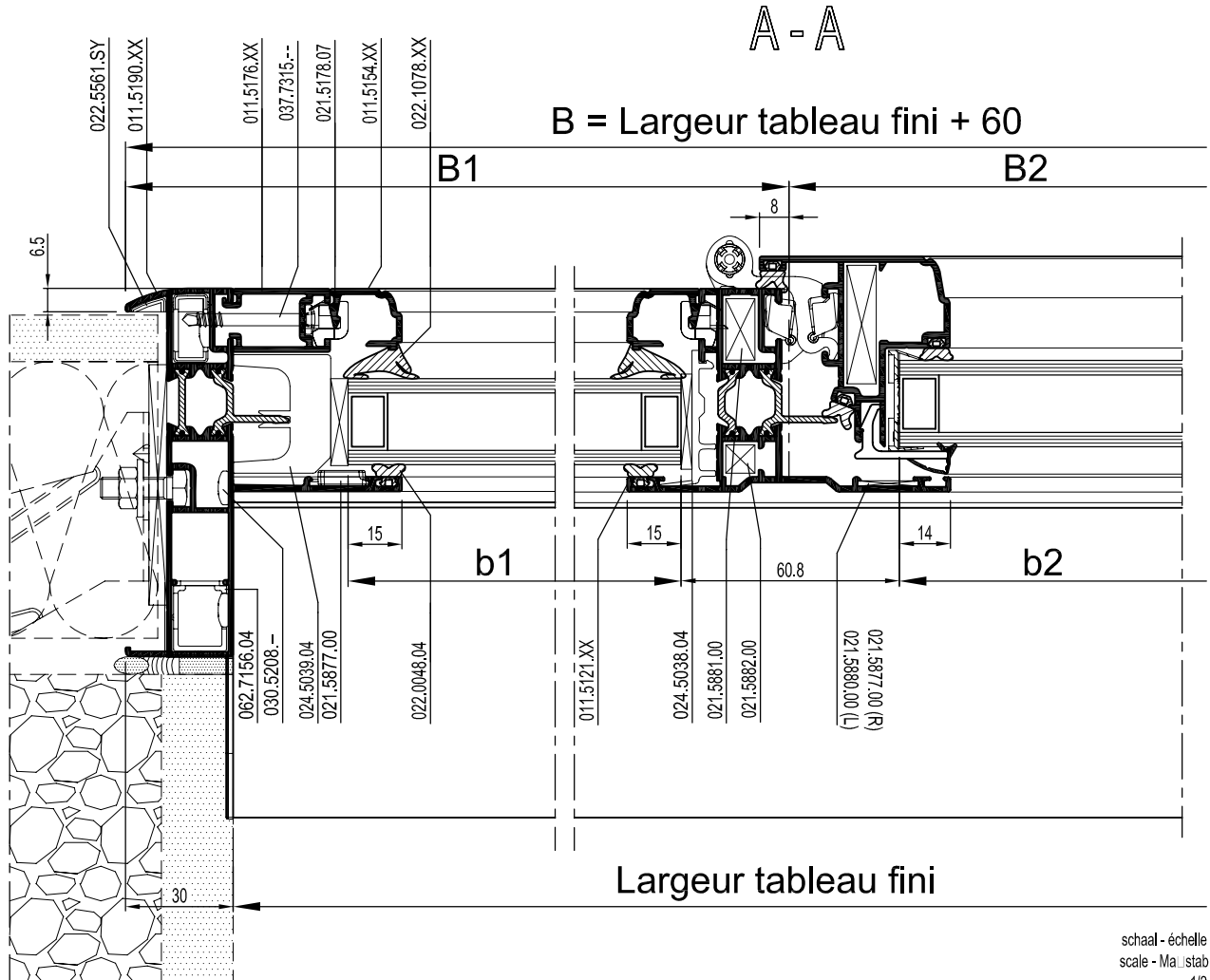

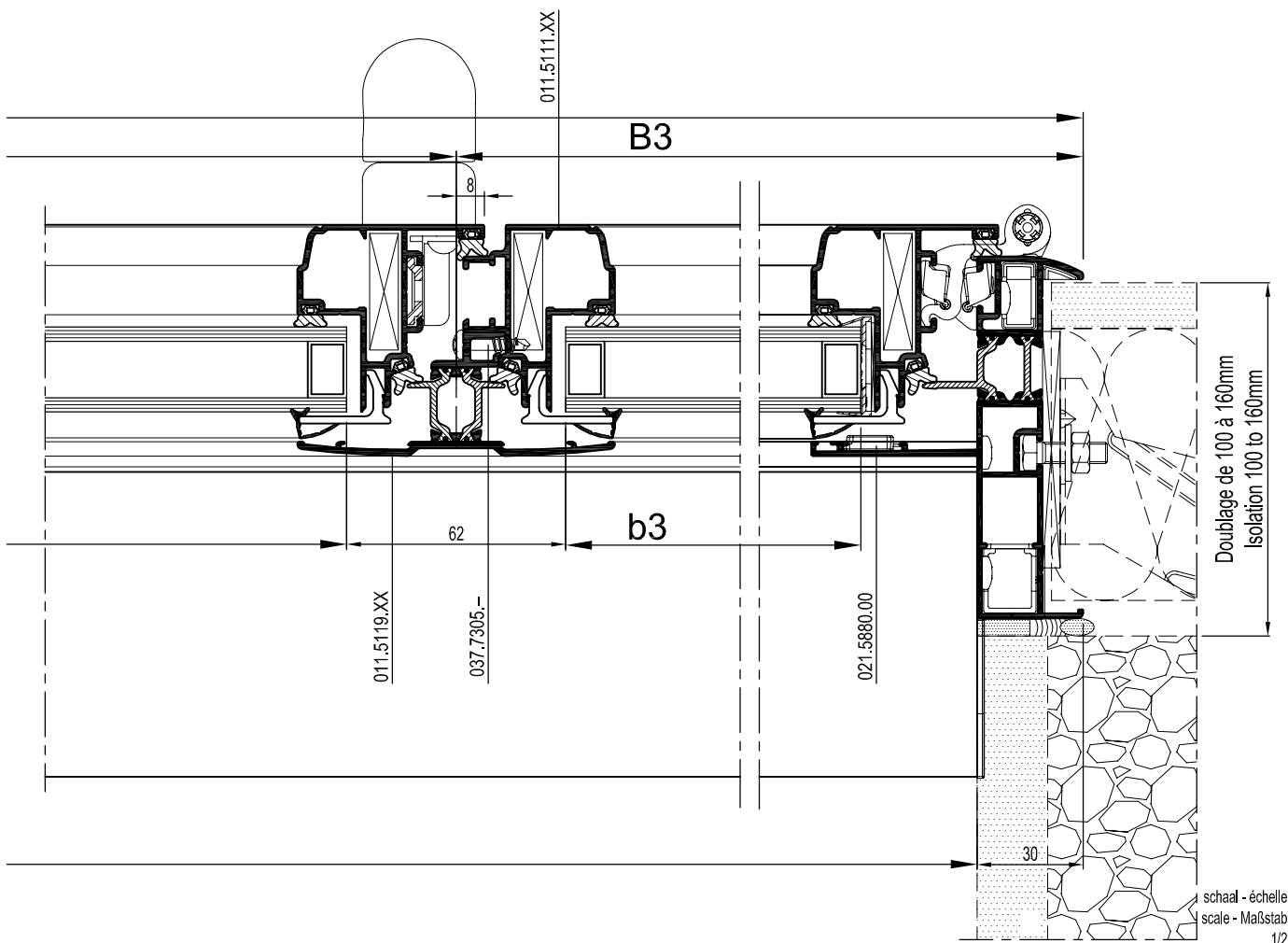

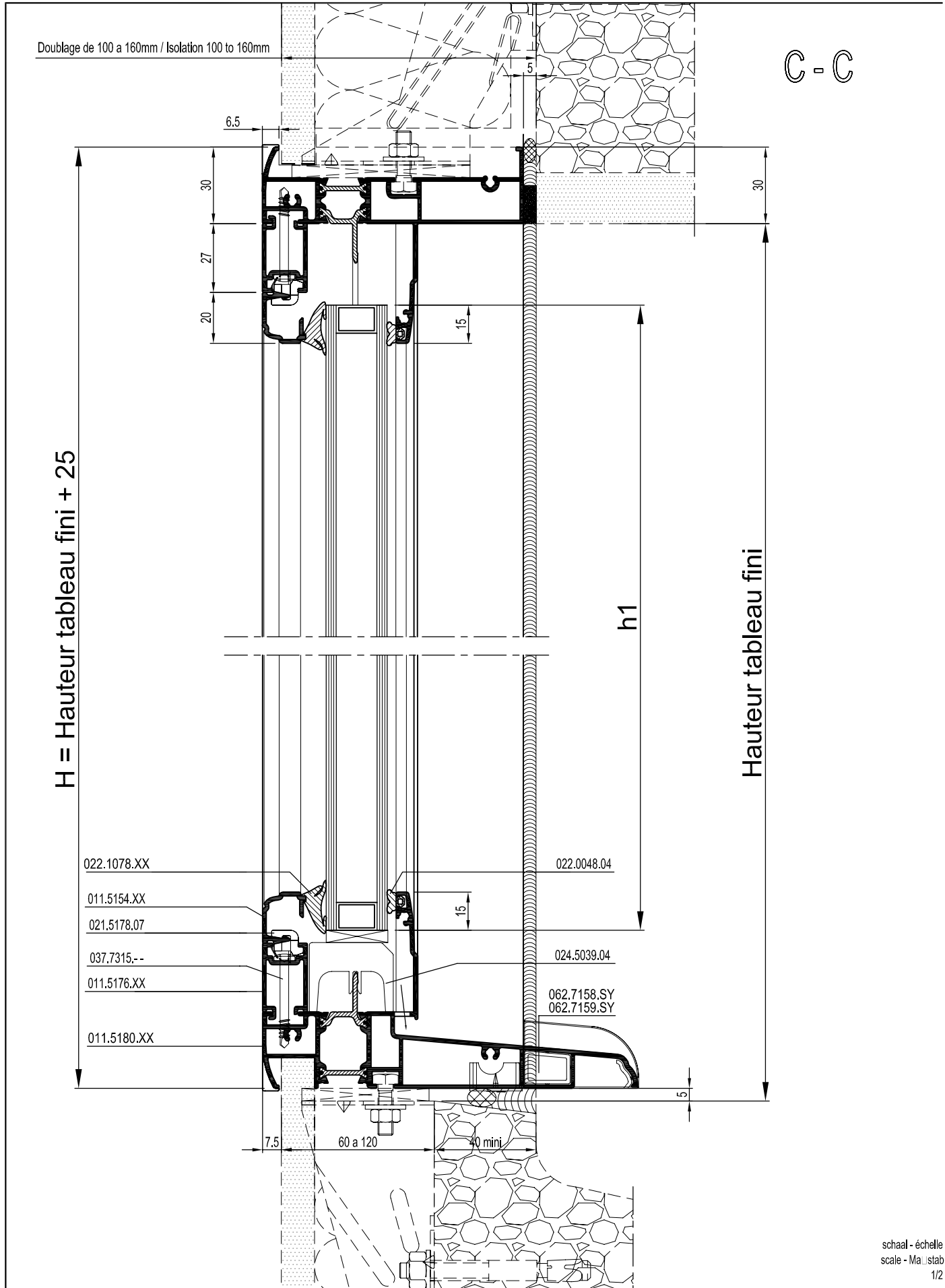

Doublage de 100 a 160mm / Isolation 100 to 160mm

B - B

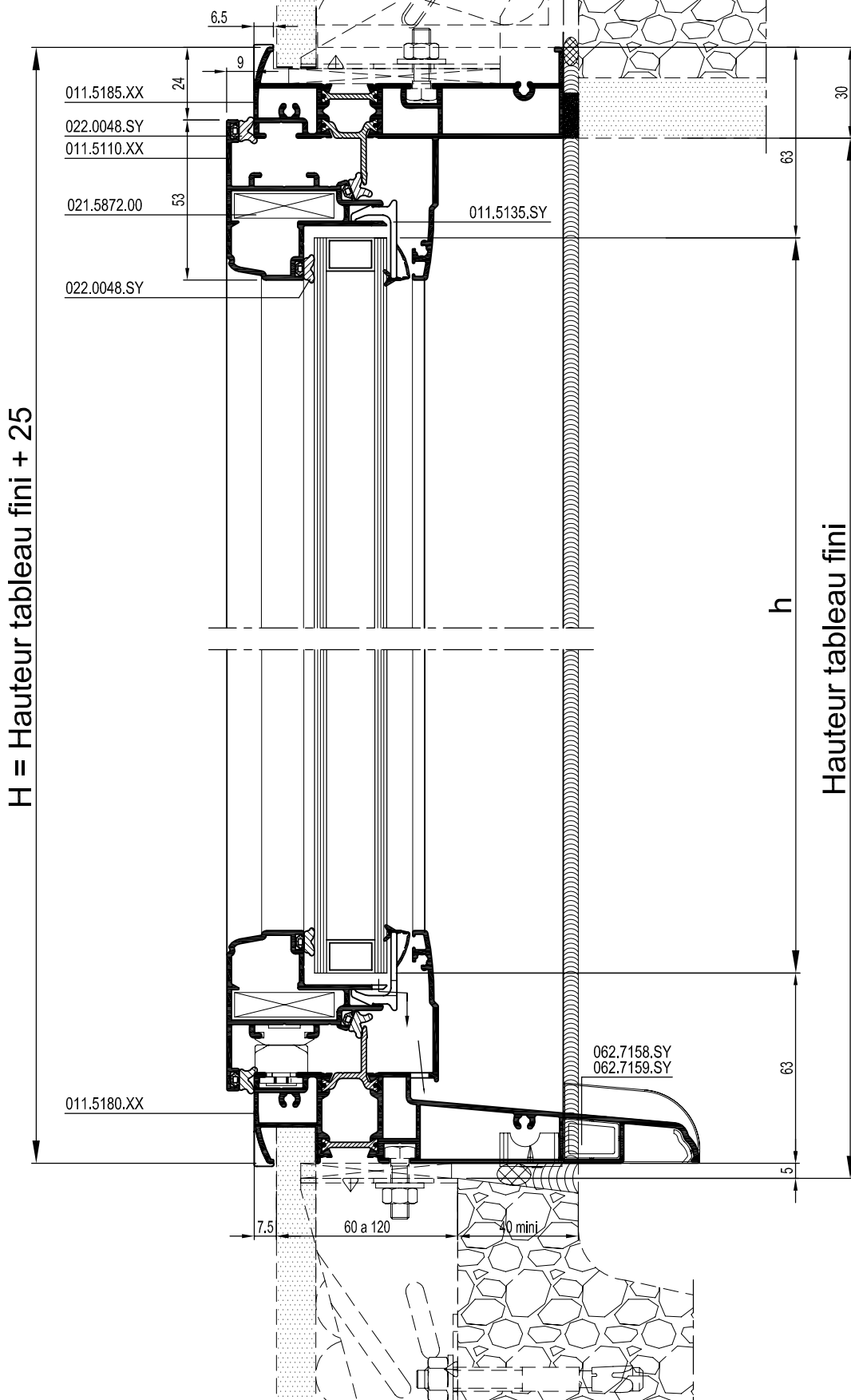

schaal - échelle
scale - Maßstab
1/2

D0035546

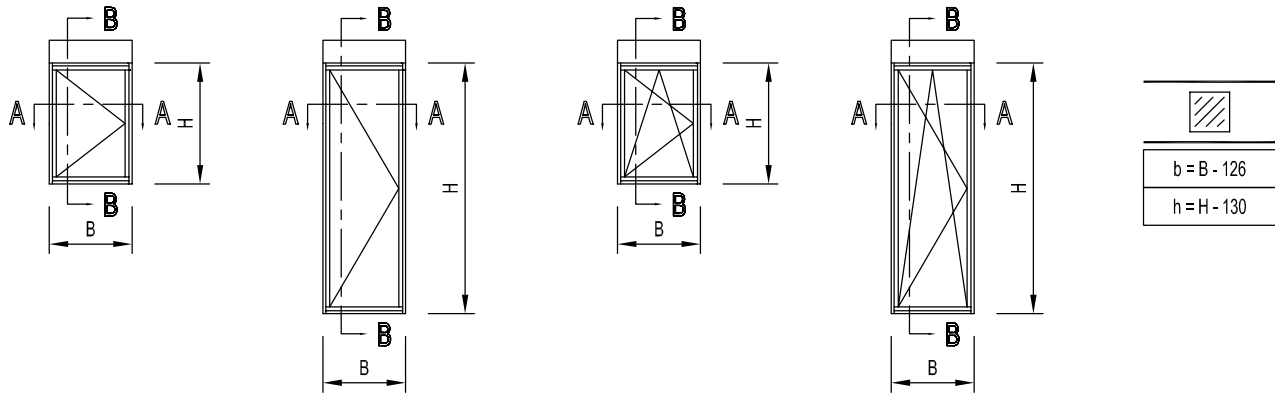

b = B - 126
h = H - 130

A - A

B = Largeur tableau fini + 60

MODELE PRESENTE
 APPUI RENTRANT
 DOUBLAGE 100 mm

PRESENT MODELE
 RECOVER SUPPORT
 ISOLATION 100 mm

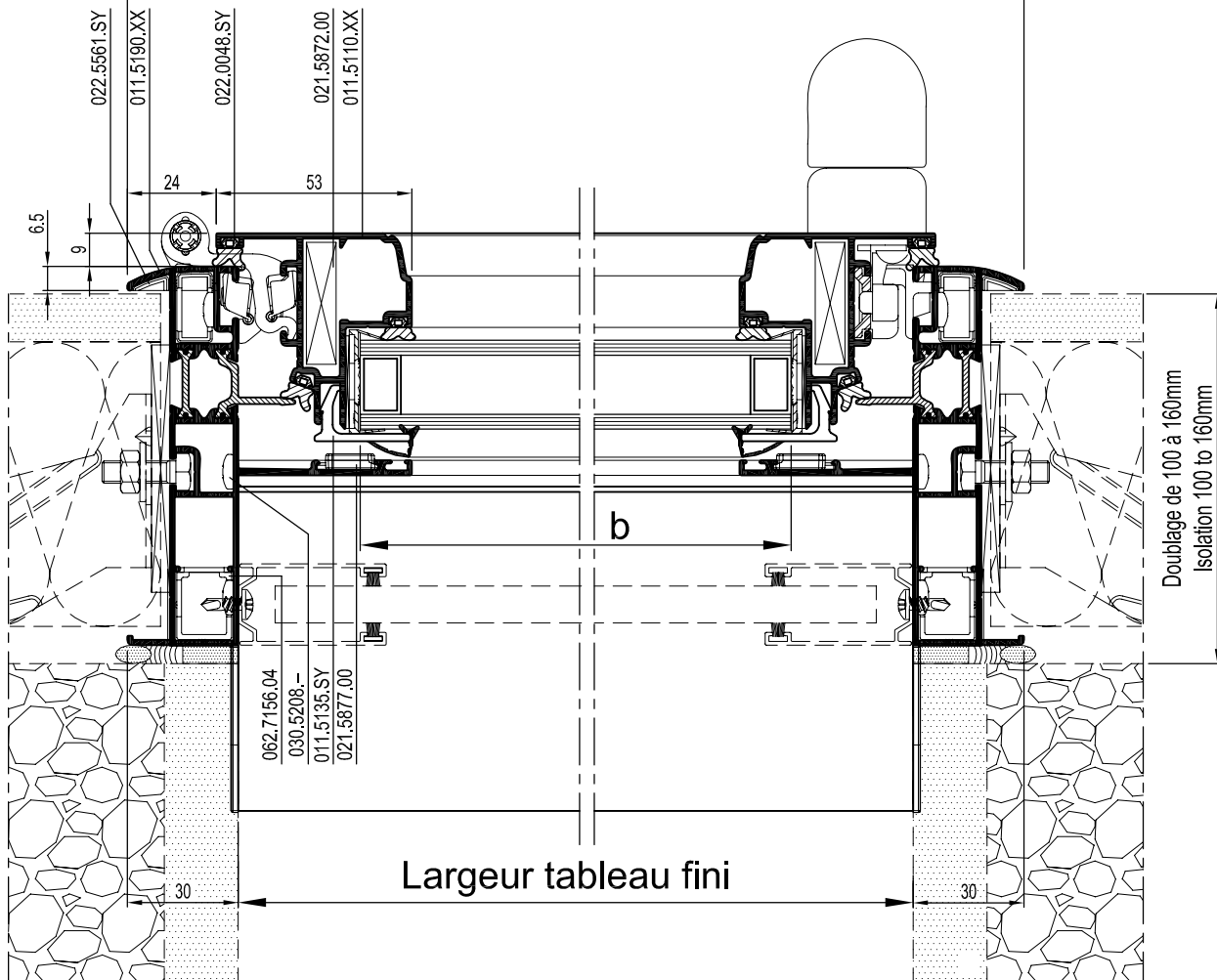

schaal - échelle
 scale - Maßstab
 1/2
 D0035549

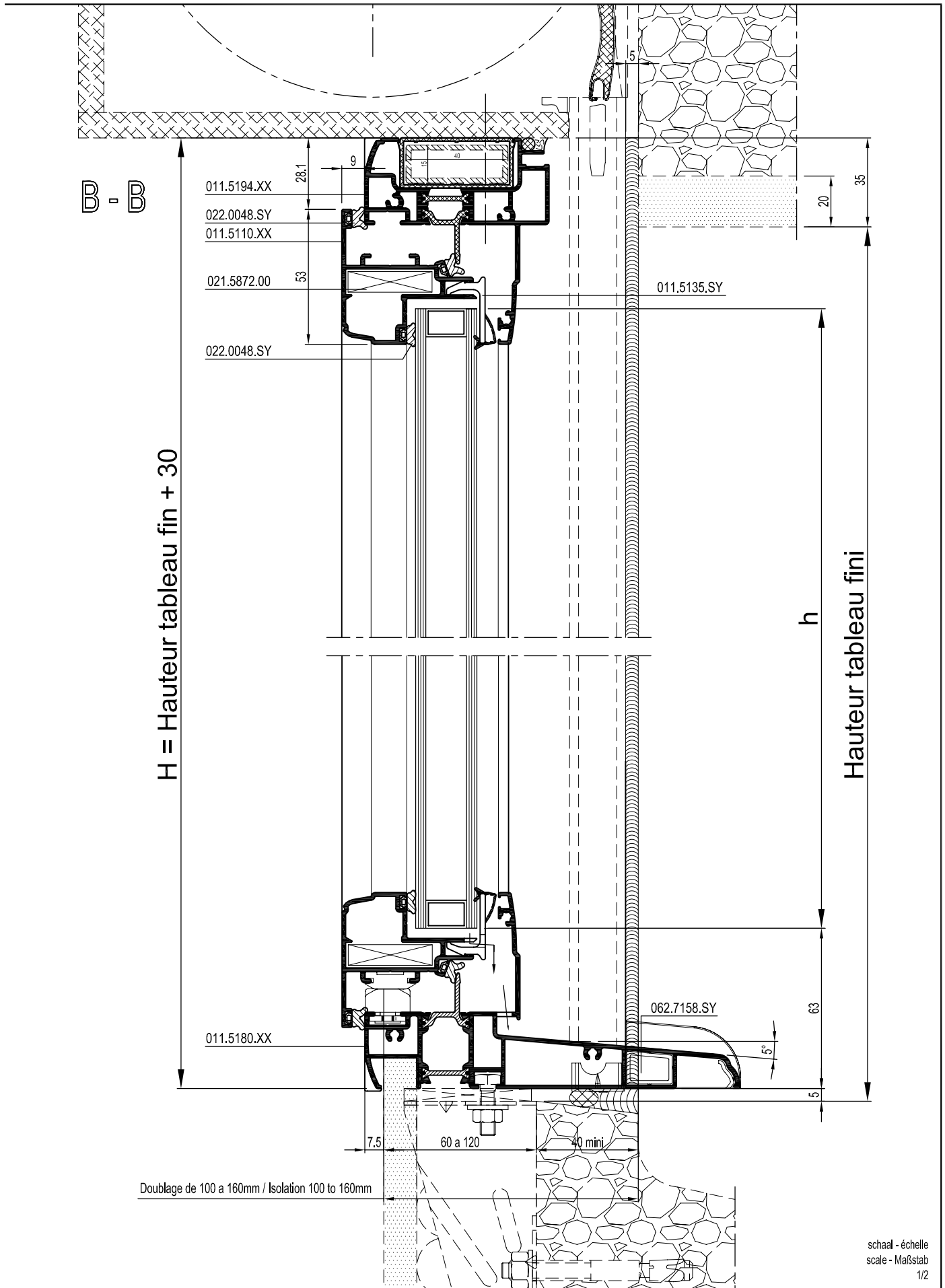

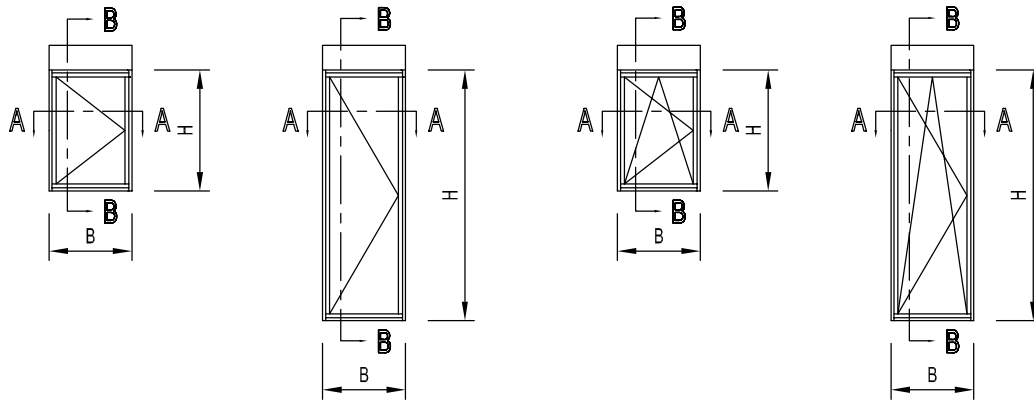

MODELE PRESENTE
 APPUI ALIGNE
 DOUBLAGE 100 mm

PRESENT MODELE
 ALIGN SUPPORT
 ISOLATION 100 mm

A - A

B = Largeur tableau fini + 60

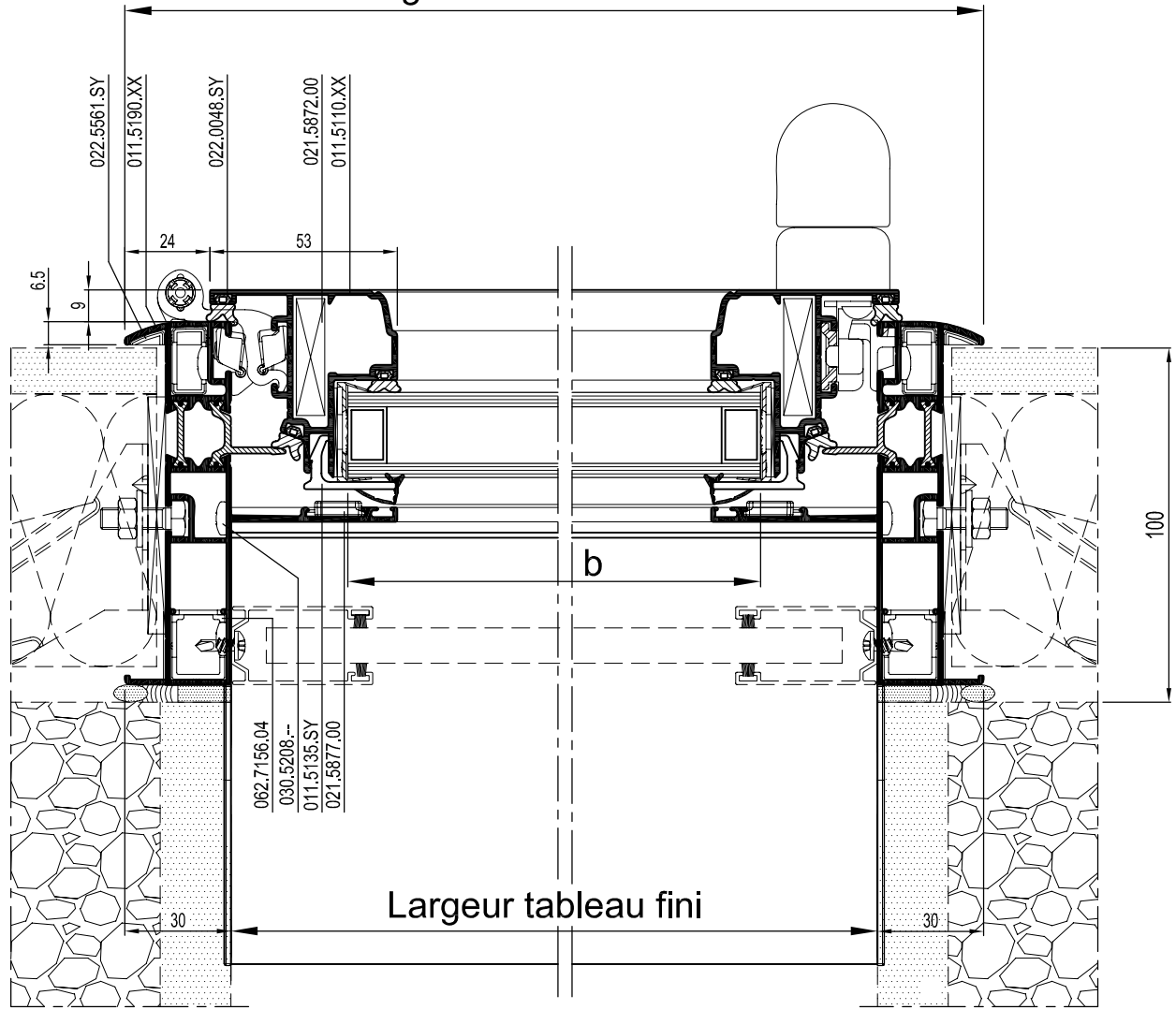

schaal - échelle
 scale - Maßstab
 1/2
 D0035552

