

XS 50	Page		
A. Généralités	83.a.a	A. General information	83.a.a
B. Généralités séries	83.b.a	B. General information systems	83.b.a
C. Profilés	83.c.a	C. Profiles	83.c.a
 D. Sections des nœuds	83.d.a	D. Section drawings	83.d.a
Eléments fixes	83.d.001	Fixed elements	83.d.001
Eléments Ouvrants	83.d.002-003	Opening elements	83.d.002-003
Eléments Ouvrants + fixes	83.d.004-005	Opening + fixed elements	83.d.004-005
Eléments composé	83.d.006	Mixed vent	83.d.006
Ouvrant dans facade	83.d.007	Vent in curtain wall	83.d.007
Monobloc	83.d.008	Monobloc	83.d.008
Coupe avec montant serrure	83.d.009	Window door and lock	83.d.009
E. Coupes et débits	83.e.a	E. Work drawings	83.e.a
F. Fabrication et montage	83.f.a	F. Assembly drawings	83.f.a
G. Nomenclatures accessoires et outillages	83.g.a	G. Accessories	83.g.a

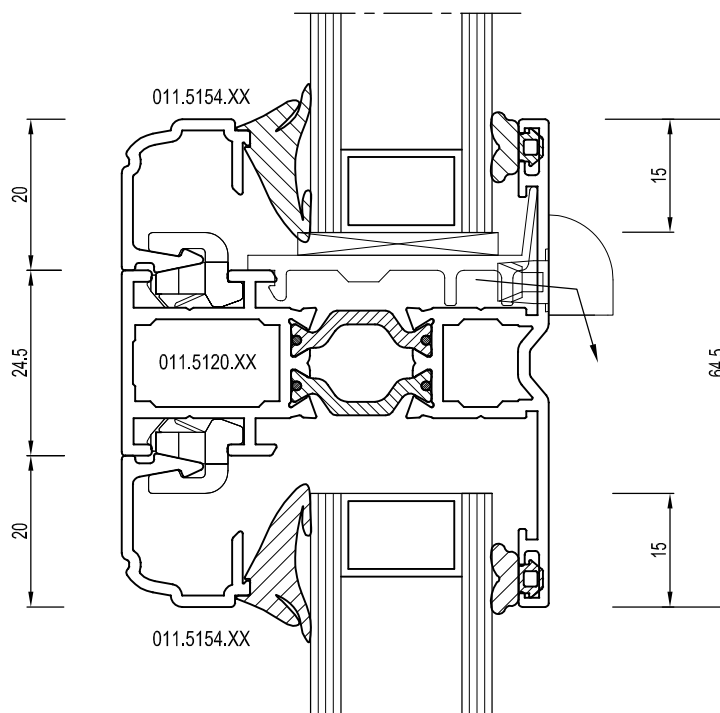

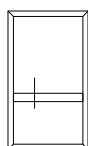

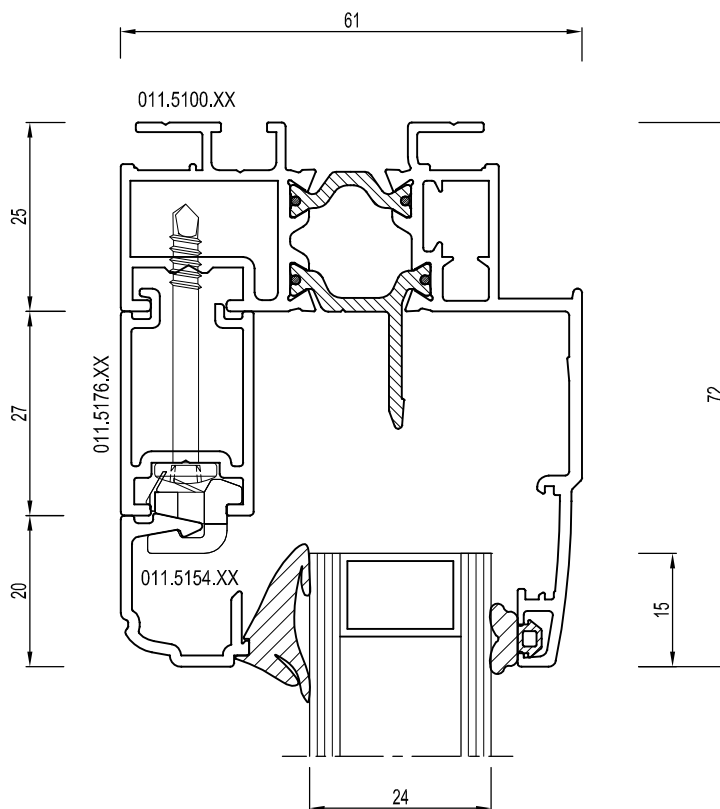

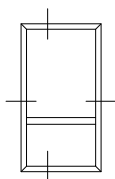
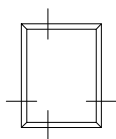
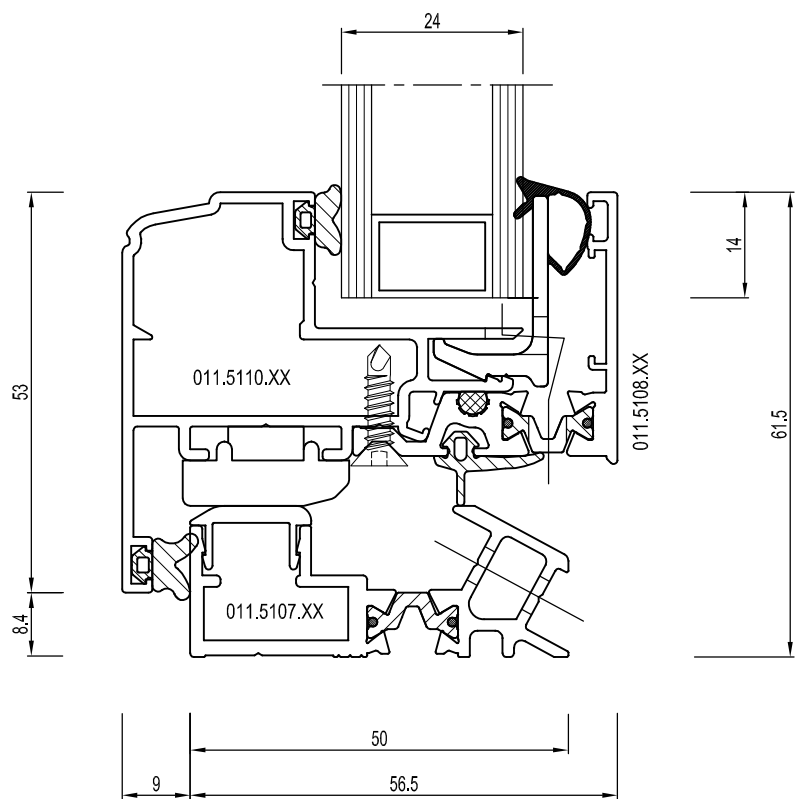
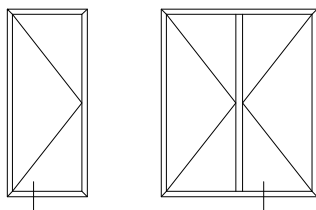
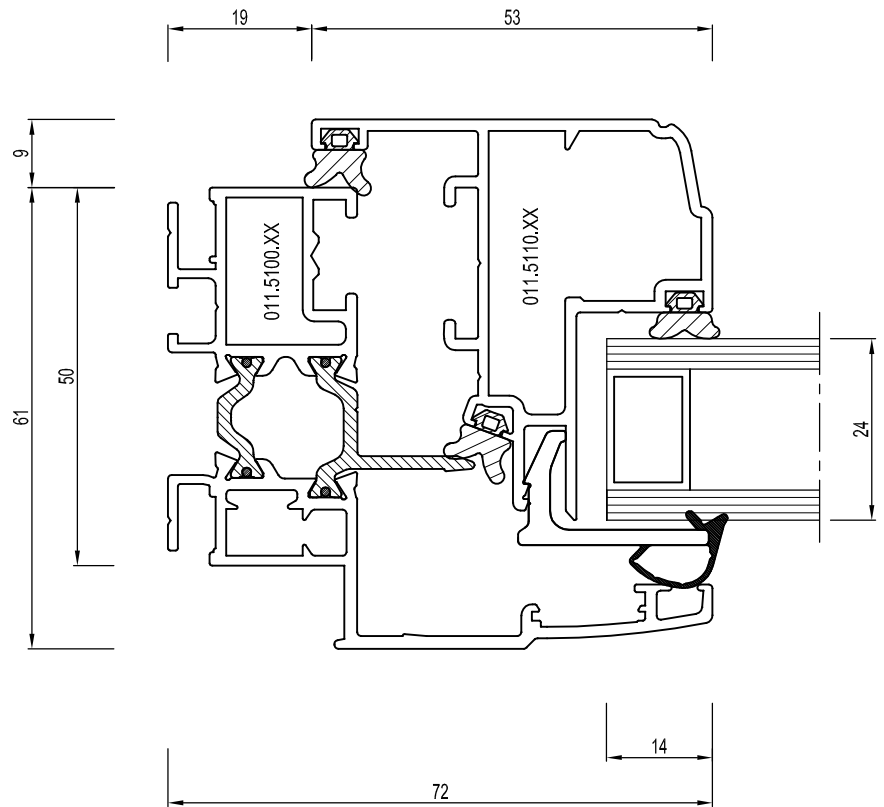
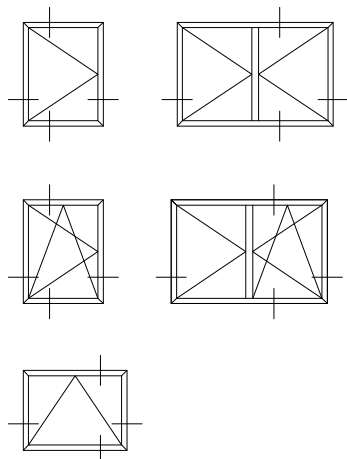
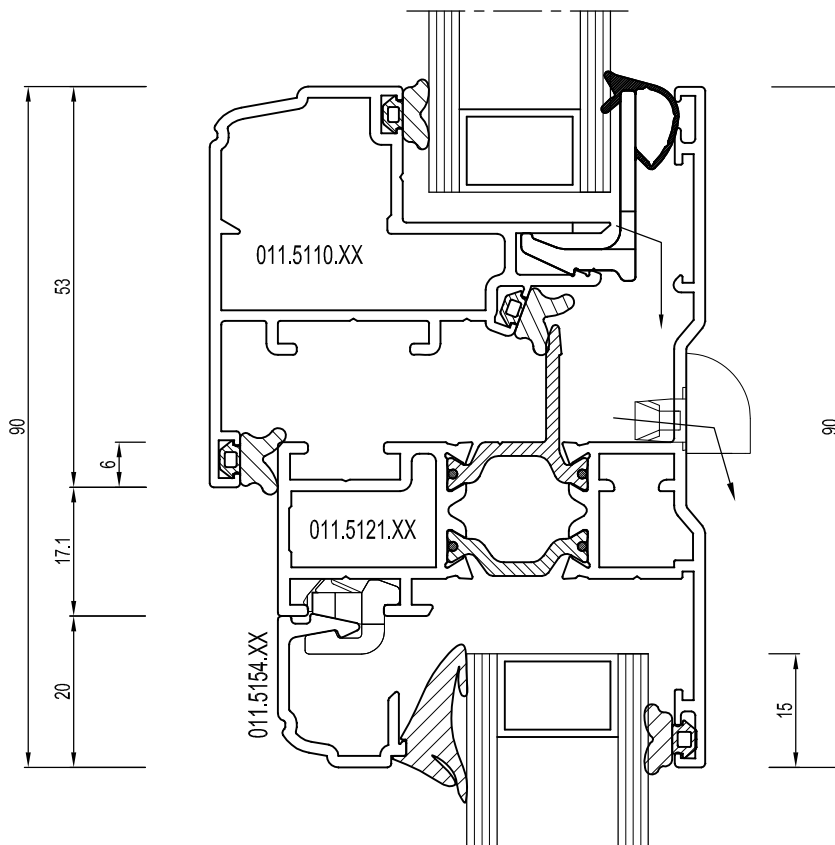
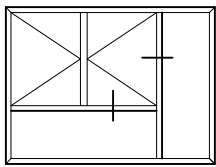
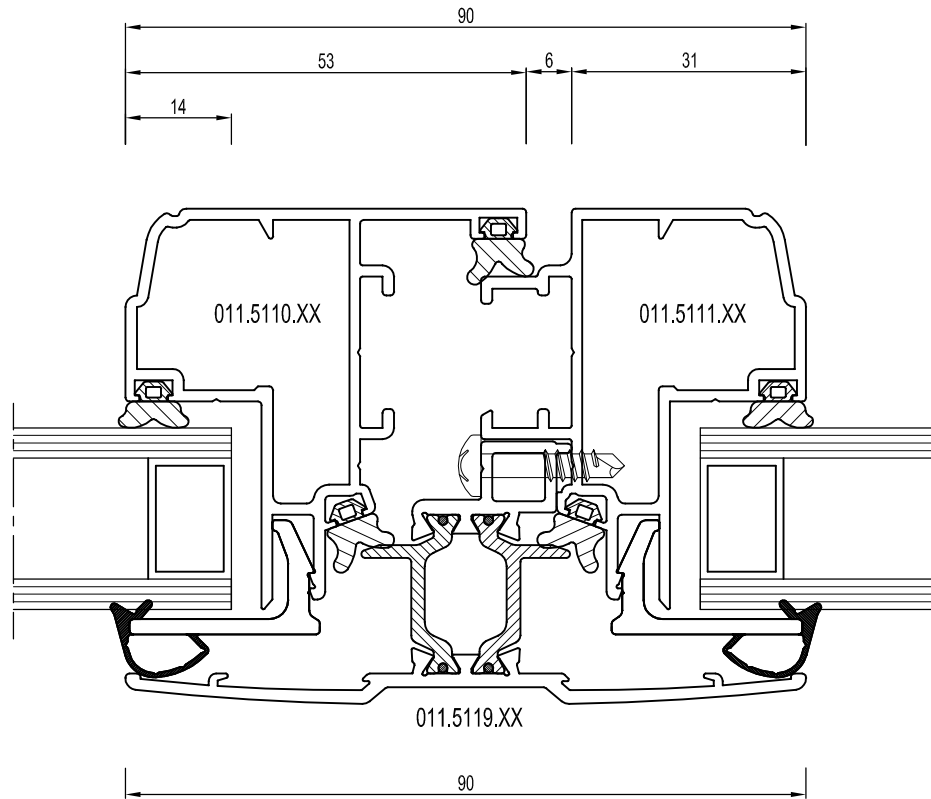
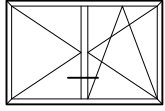
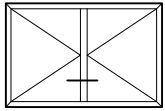
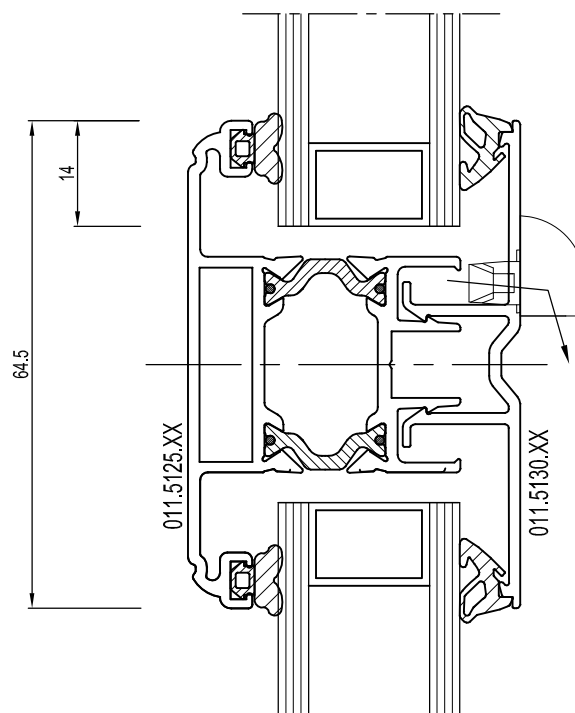
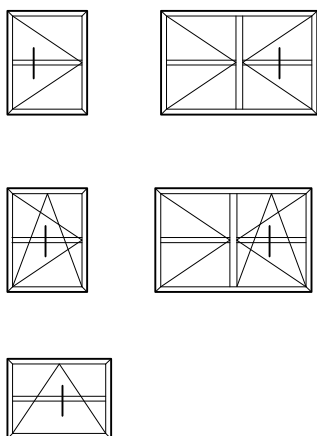
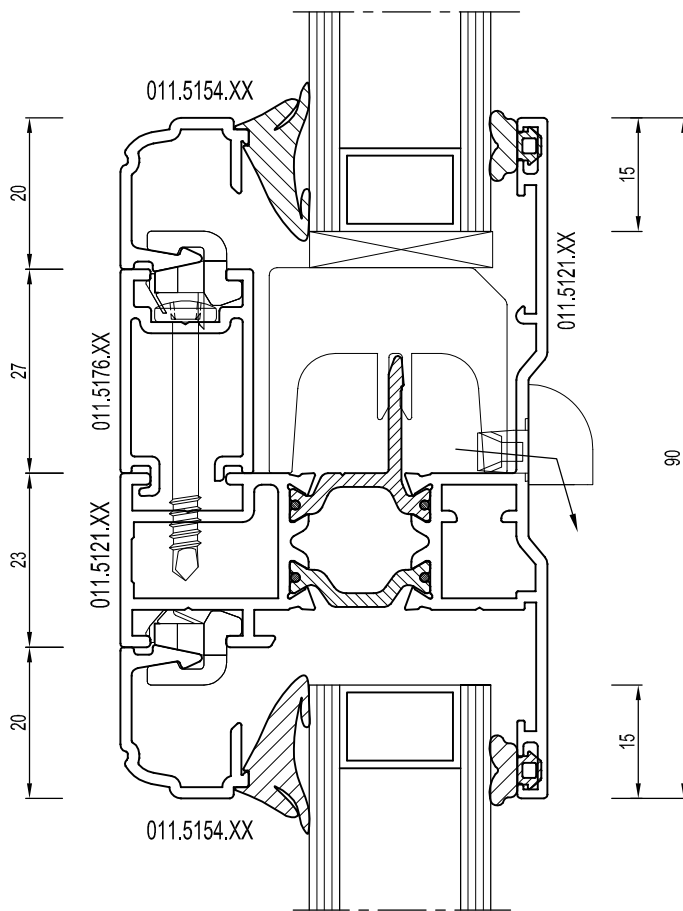
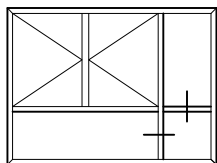

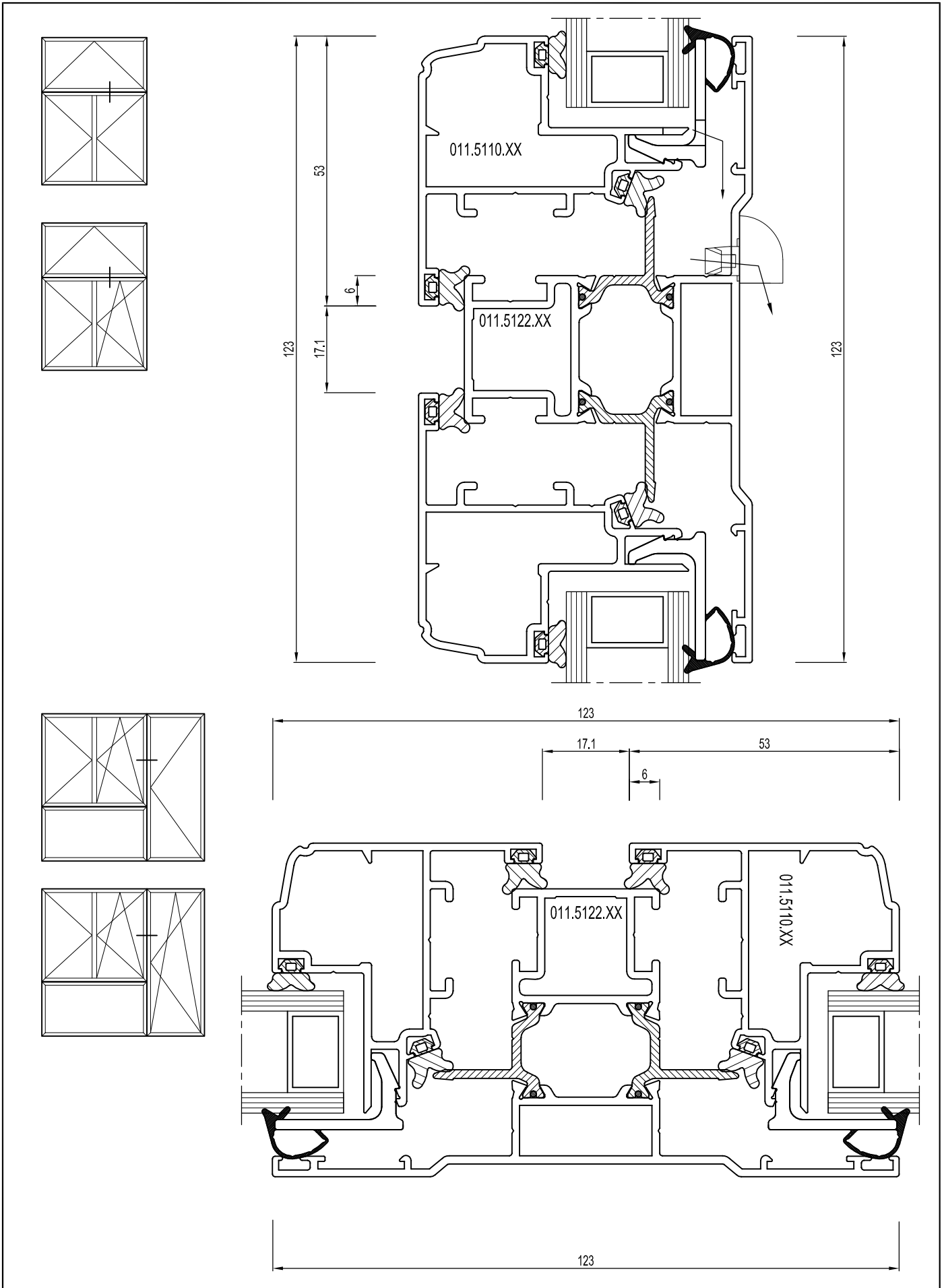

D0037092

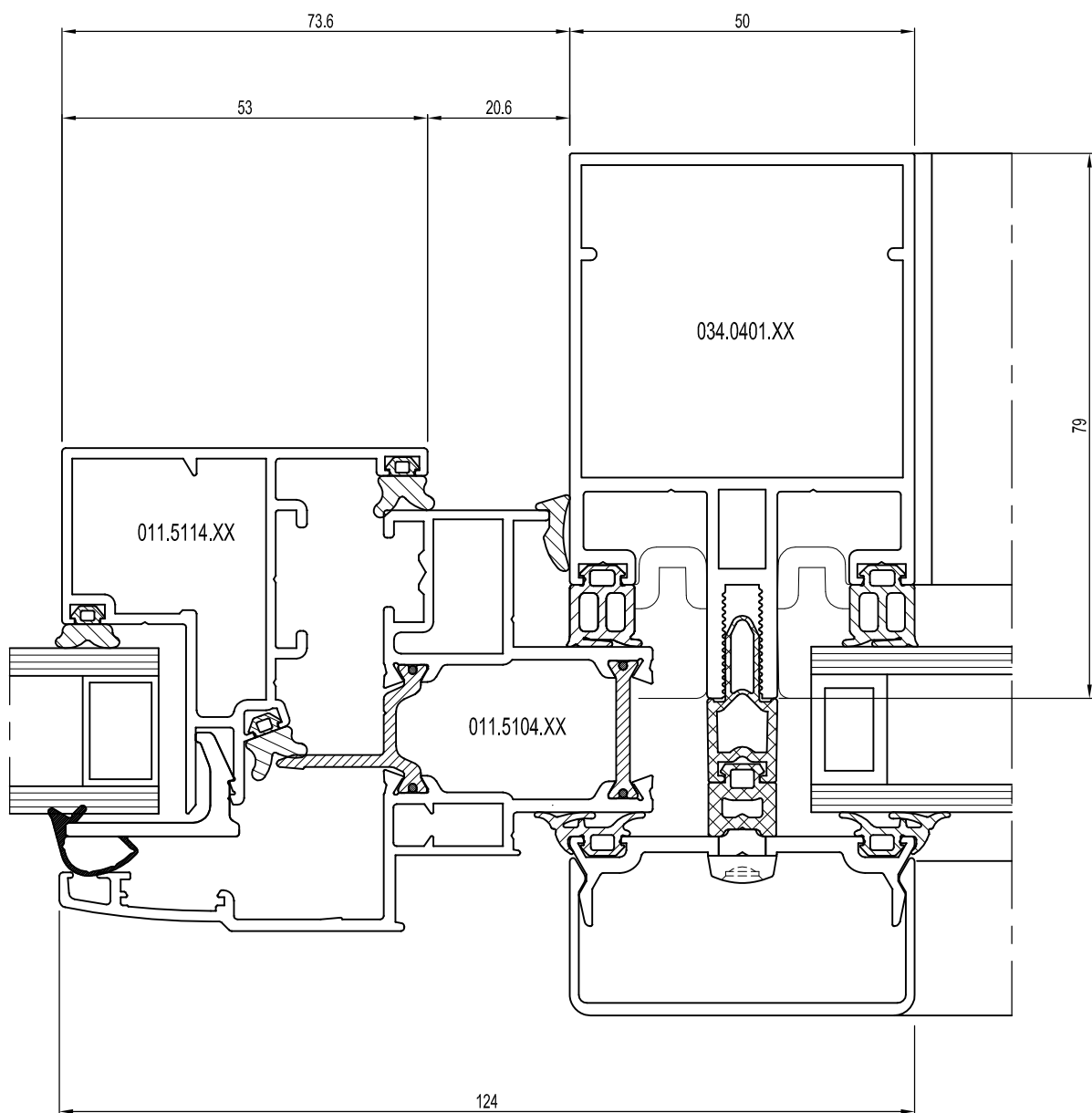
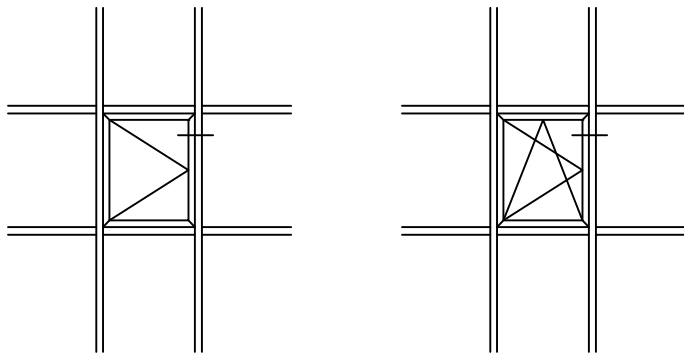

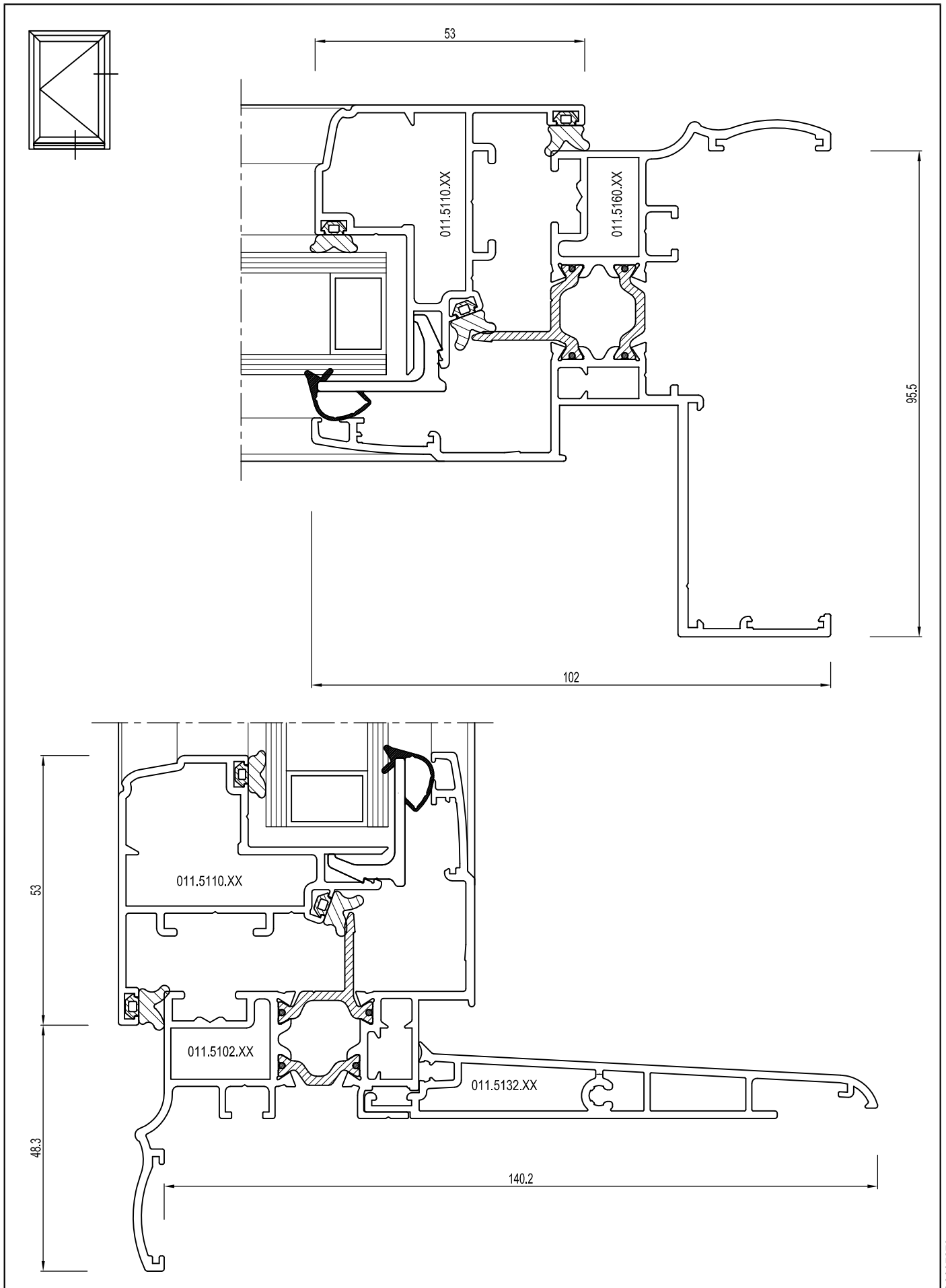

D00037273

